

ALLEGATO 1 AL MANUALE DI ISTRUZIONI INFORMAZIONI SUL FABBRICANTE

In tutte le parti del presente manuale nelle quali si fa riferimento, quale fabbricante, a una delle seguenti società:

- Ravaglioli S.p.A., P.IVA e C.F.: 01759471202, con sede legale in Sasso Marconi (BO), Via 1° Maggio, 3, Italia
- Butler Engineering and Marketing S.p.A., P.IVA: 01741580359, C.F.: 01824810368, con sede legale in Rolo (RE), Via dell'Ecologia, 6, Italia
- Space S.r.l., P.IVA e C.F.: 07380730015, con sede legale in Trana (TO), Via Sangano, 48, Italia

tale società deve essere intesa come:

Vehicle Service Group Italy S.r.l.

P.IVA: 01426630388

C.F.: 01633631203

con sede legale in Ostellato (FE), Via Brunelleschi, 9, Italia

per effetto della intervenuta fusione per incorporazione delle citate Ravaglioli S.p.A., Butler Engineering and Marketing S.p.A. e Space S.r.l. in Officine Meccaniche Sirio S.r.l., ridenominata, a seguito della fusione, Vehicle Service Group Italy S.r.l., avente efficacia giuridica a far data dal 1° luglio 2023.

Il presente Allegato 1 al Manuale di istruzioni costituisce parte integrante del Manuale di istruzioni stesso.

Simone Ferrari

Direttore Generale



Vehicle Service Group Italy S.r.l.

Via Filippo Brunelleschi 9
44020 Ostellato (FE) Italy

VAT no.: 01426630388 | Tax no.: 01633631203

ANNEX 1 TO THE INSTRUCTION MANUAL MANUFACTURER INFORMATION

In all parts of the present manual in which reference is made to one of the following companies as the manufacturer:

- Ravaglioli S.p.A., VAT Number and Tax Code: 01759471202, with registered office in Sasso Marconi (BO), Via 1° Maggio, 3, Italy
- Butler Engineering and Marketing S.p.A., VAT Number: 01741580359, Tax Code: 01824810368, with registered office in Rolo (RE), Via dell'Ecologia, 6, Italy
- Space S.r.l., VAT Number and Tax Code: 07380730015, with registered office in Trana (TO), Via Sangano, 48, Italy

this company is to be understood as:

Vehicle Service Group Italy S.r.l.

VAT Number: 01426630388

Tax Code: 01633631203

with registered office in Ostellato (FE), Via Brunelleschi, 9, Italy

as a result of the intervened merger by incorporation of the aforementioned Ravaglioli S.p.A., Butler Engineering and Marketing S.p.A. and Space S.r.l. into Officine Meccaniche Sirio S.r.l., renamed, following the merger, as Vehicle Service Group Italy S.r.l., having legal effect as of July 1st, 2023.

This Annex 1 to the Instruction Manual is an integral part of the Instruction Manual itself.

Simone Ferrari

Managing Director



Vehicle Service Group Italy S.r.l.

Via Filippo Brunelleschi 9
44020 Ostellato (FE) Italy

VAT no.: 01426630388 | Tax no.: 01633631203

ANLAGE 1 ZUR BEDIENUNGSANLEITUNG HERSTELLERANGABEN

In allen Teilen der vorliegenden Bedienungsanleitung, in denen auf eine der folgenden Gesellschaften:

- Ravaglioli S.p.A., Umsatzsteuer-Identifikationsnummer und Italienische Steuernummer: 01759471202, mit Rechtssitz in Sasso Marconi (BO), Via 1° Maggio, 3, Italien
- Butler Engineering and Marketing S.p.A., Umsatzsteuer-Identifikationsnummer 01741580359, und Italienische Steuernummer: 01824810368, mit Rechtssitz in Rolo (RE), Via dell'Ecologia, 6, Italien
- Space S.r.l., Umsatzsteuer-Identifikationsnummer und Italienische Steuernummer: 07380730015, mit Rechtssitz in Trana (TO), Via Sangano, 48, Italien

als Hersteller Bezug genommen wird, ist diese Gesellschaft zu verstehen als:

Vehicle Service Group Italy S.r.l.

UMSATZSTEUER-IDENTIFIKATIONSNUMMER: 01426630388

ITALIENISCHE STEUERNUMMER: 01633631203

mit eingetragenem Rechtssitz in Ostellato (FE), Via Brunelleschi, 9, Italien

als Folge der verschmelzenden Übernahme der vorgenannten Ravaglioli S.p.A., Butler Engineering and Marketing S.p.A. und Space S.r.l. in die Officine Meccaniche Sirio S.r.l., die nach der Verschmelzung mit rechtlicher Wirkung zum 1. Juli 2023 in Vehicle Service Group Italy S.r.l. umbenannt wurde.

Die vorliegende Anlage 1 zur Bedienungsanleitung ist integrierender Bestandteil der Betriebsanleitung selbst.

Simone Ferrari

Geschäftsführer



Vehicle Service Group Italy S.r.l.

Via Filippo Brunelleschi 9
44020 Ostellato (FE) Italy
VAT no.: 01426630388 | Tax no.: 01633631203

ANNEXE 1 DU MANUEL D'INSTRUCTIONS INFORMATIONS SUR LE FABRICANT

Dans toutes les parties de ce manuel où il est fait référence à l'une des sociétés suivantes en tant que fabricant:

- Ravaglioli S.p.A., numéro de TVA et code fiscal: 01759471202, dont le siège social est situé à Sasso Marconi (BO), Via 1° Maggio, 3, Italie
- Butler Engineering and Marketing S.p.A., numéro de TVA: 01741580359, code fiscal: 01824810368, dont le siège est à Rolo (RE), Via dell'Ecologia, 6, Italie
- Space S.r.l., numéro de TVA et code fiscal: 07380730015, dont le siège est à Trana (TO), Via Sangano, 48, Italie

cette société doit être sous-entendue comme:

Vehicle Service Group Italy S.r.l.

numéro de TVA: 01426630388

code fiscal: 01633631203

dont le siège social est situé à Ostellato (FE), Via Brunelleschi, 9, Italie

à la suite de la fusion par incorporation des sociétés Ravaglioli S.p.A., Butler Engineering and Marketing S.p.A. et Space S.r.l. dans Officine Meccaniche Sirio S.r.l., renommée, à la suite de la fusion, Vehicle Service Group Italy S.r.l., avec effet juridique à compter du 1er juillet 2023.

La présente Annexe 1 au Manuel d'instructions fait partie intégrante du Manuel d'instructions lui-même.

Simone Ferrari

Directeur Général



Vehicle Service Group Italy S.r.l.

Via Filippo Brunelleschi 9
44020 Ostellato (FE) Italy

VAT no.: 01426630388 | Tax no.: 01633631203

ANEXO 1 AL MANUAL DE INSTRUCCIONES INFORMACIÓN DEL FABRICANTE

En todas las partes de este manual en las que se haga referencia a una de las siguientes empresas como fabricante:

- Ravaglioli S.p.A., número de IVA y código fiscal: 01759471202, con domicilio social en Sasso Marconi (BO), vía 1° Maggio, 3, Italia
- Butler Engineering and Marketing S.p.A., número de IVA: 01741580359, código fiscal: 01824810368, con domicilio social en Rolo (RE), vía dell'Ecologia, 6, Italia
- Space S.r.l., número de IVA y código fiscal: 07380730015, con domicilio social en Trana (TO), vía Sangano, 48, Italia

que debe entenderse por sociedad:

Vehicle Service Group Italy S.r.l.

Número de IVA: 01426630388

código fiscal: 01633631203

con domicilio social en Ostellato (FE), vía Brunelleschi, 9, Italia

como resultado de la fusión por incorporación de las mencionadas Ravaglioli S.p.A., Butler Engineering and Marketing S.p.A. y Space S.r.l. en Officine Meccaniche Sirio S.r.l., rebautizada, tras la fusión, Vehicle Service Group Italy S.r.l., con efectos jurídicos a partir del 1 de julio de 2023.

El presente Anexo 1 del Manual de Instrucciones forma parte integrante del mismo.

Simone Ferrari

Director Gerente



Vehicle Service Group Italy S.r.l.

Via Filippo Brunelleschi 9
44020 Ostellato (FE) Italy

VAT no.: 01426630388 | Tax no.: 01633631203

1296-M024-00

LIBRAK350

INSTRUCTION MANUAL

EN

TRANSLATION FROM THE
ORIGINAL INSTRUCTIONS

For spare parts drawings refer to "LIST OF COMPONENTS" section.

- For any further information please contact your local dealer or call:

BUTLER ENGINEERING and MARKETING S.p.A. a s. u.
Via dell'Ecologia, 6 - 42047 Rolo - (RE) Italy
Phone (+39) 0522 647911 - Fax (+39) 0522 649760 - e-mail: Info@butler.it

1296-M024-00- Rev. n. 00 (04/2021)

SUMMARY





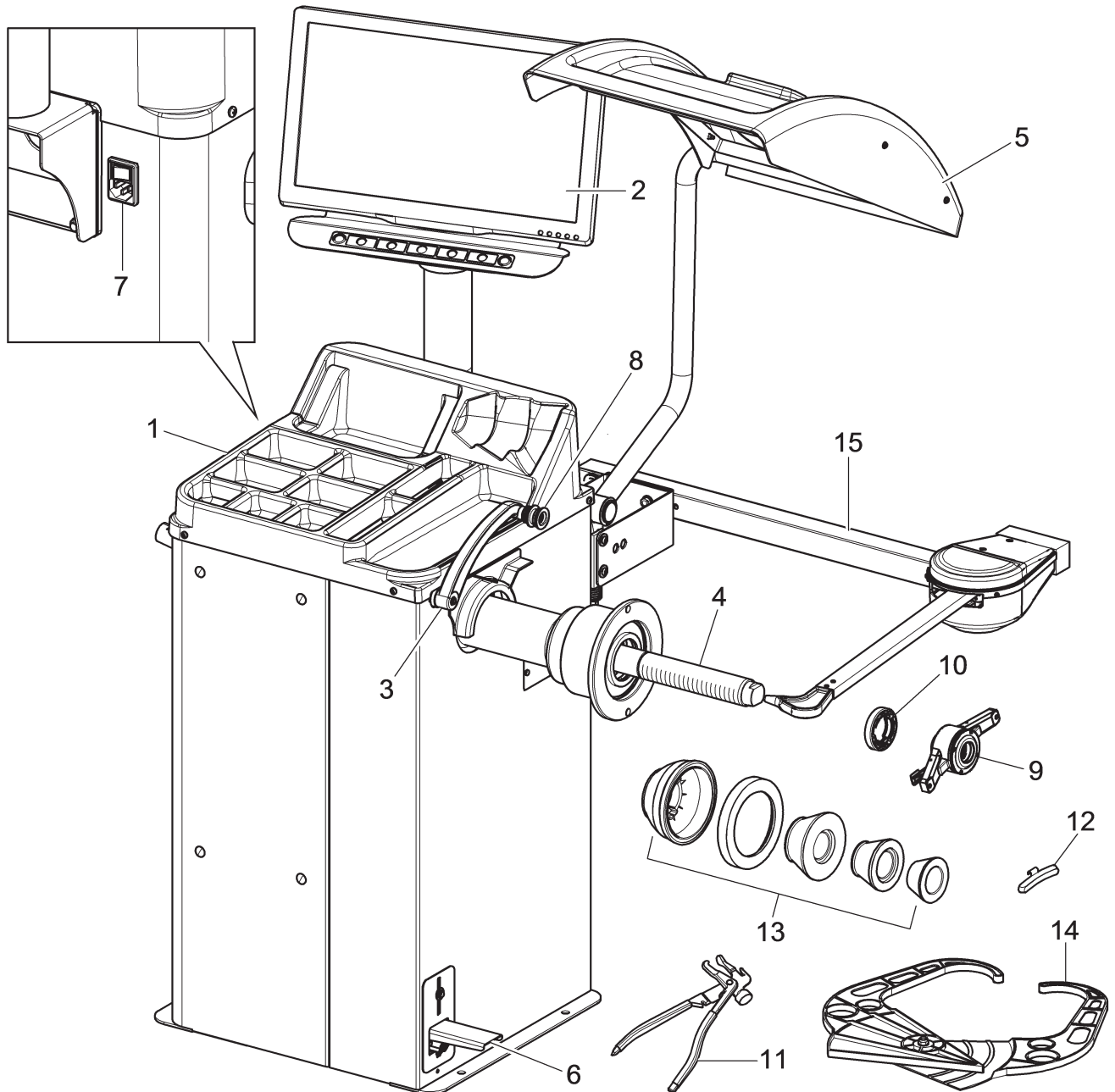

GENERAL DESCRIPTION _____	4	13.2.2 Programs setting through “Measurements acquisition” screen page _____	22
SYMBOLS USED IN THE MANUAL _____	5	13.3 Indicative display of points where to detect measures/to fit weight _____	23
INFORMATION PLATE LOCATION DRAWING _____	6	13.3.1 Weights positioning _____	24
1.0 GENERAL INTRODUCTION _____	7	13.4 Displaying the active/modifiable field _____	24
1.1 Introduction _____	7	13.5 Wheel balancing screen page description _____	25
2.0 INTENDED USE _____	7	13.5.1 Balancing mode _____	27
2.1 Training of personnel _____	7	13.6 Use of machines with disabled automatic data gauge _____	29
3.0 SAFETY DEVICES _____	8	13.6.1 Manual setting of wheel dimensions _____	29
3.1 Residual risks _____	8	13.7 Standard balancing programs _____	30
4.0 GENERAL SAFETY RULES _____	8	13.7.1 Static _____	30
5.0 PACKING AND MOBILIZATION FOR TRANSPORT _____	9	13.7.2 Static-1 _____	30
6.0 UNPACKING _____	10	13.7.3 Static-2 _____	30
7.0 MOBILIZATION _____	10	13.7.4 Dynamic _____	30
8.0 WORKING ENVIRONMENT CONDITIONS _____	11	13.7.5 ALU-S _____	31
8.1 Working area _____	11	13.7.6 ALU-S1 _____	31
8.2 Lighting _____	11	13.7.7 ALU-S2 _____	31
9.0 MACHINE ASSEMBLY _____	12	13.7.8 ALU-1 _____	31
9.1 Anchoring system _____	12	13.7.9 ALU-2 _____	32
9.2 Assembly procedures _____	13	13.7.10 ALU-3 _____	32
9.2.1 Fitting the shaft on the flange _____	13	13.7.11 ALU-4 _____	32
9.2.2 Fitting the protection guard (without width measuring device) _____	13	13.8 Optional balancing programs _____	33
9.2.3 Monitor fitting _____	14	13.8.1 ECO-WEIGHT mode _____	33
9.2.4 Fitting of external data gauge (optional) _____	15	13.8.2 SPLIT mode _____	35
10.0 ELECTRICAL CONNECTIONS _____	16	13.8.3 Weights hidden behind spokes mode _____	37
10.1 Electrical checks _____	16	13.8.4 Matching mode _____	38
11.0 FITTING THE WHEEL ON THE SHAFT _____	17	13.9 Special balancing programs _____	41
11.1 Wheel assembly _____	17	13.9.1 Pax _____	41
12.0 CONTROL PANEL _____	18	13.10 Recalculation function _____	41
13.0 WHEEL BALANCING _____	18	13.11 Wheel balancing in Motorcycle mode (with distance caliper extension Kit) _____	42
13.1 Switching the machine on and off _____	18	14.0 USER MENU (OPTIONS AND CALIBRATION) _____	42
13.2 Balancing programs setting _____	19	14.1 Options menu _____	43
13.2.1 Programs rapid setting and measurements through distance- diameter caliper arm _____	20	14.1.1 Lower weight limit _____	45
		14.1.2 Setting adhesive weight dimen- sions and static threshold percentage _____	45
		14.1.3 User management _____	46
		14.2 Enabling of electronic Run-out measuring device (optional) _____	47
		14.3 Machine calibrations _____	48
		14.3.1 Chuck “0” (zero) calibration _____	48
		14.3.2 Weight measurement sensors calibration _____	49
		14.3.3 Gauges calibration _____	50





14.0 ERROR SIGNALS _____	54	18.0 STORING _____	58
16.0 ROUTINE MAINTENANCE _____	55	19.0 SCRAPPING _____	58
17.0 TECHNICAL DATA _____	56	20.0 REGISTRATION PLATE DATA _____	58
17.1 Technical electrical data _____	56	21.0 FUNCTIONAL DIAGRAMS _____	58
17.2 Technical mechanical data _____	56	<i>Drawing A - Electrical connection diagram</i> _____	55
17.3 Dimensions _____	57		

GENERAL DESCRIPTION**Fig. 1****KEY**

- 1 - Weight holding bridge
- 2 - Monitor
- 3 - Distance-diameter caliper
- 4 - Threaded chuck
- 5 - Protection guard
- 6 - Pedal brake
- 7 - Main switch
- 8 - Grippers for weight fitting
- 9 - Rapid ring nut
- 10 - Pressure ring
- 11 - Grippers for weights
- 12 - Carriages counterweight
- 13 - Cones + protection cup
- 14 - Manual caliper
- 15 - External data gauge (optional)

SYMBOLS USED IN THE MANUAL

Symbols	Description
	Read instruction manual.
	Wear work gloves.
	Wear work shoes.
	Wear safety goggles.
	Warning. Be particularly careful (possible material damages).
	Mandatory. Operations or jobs to be performed compulsorily.

Symbols	Description
	Danger! Be particularly careful.
	Move with fork lift truck or pallet truck.
	Lift from above.
	Note. Indication and/or useful information.
	Attention: never lift the machine by means of the chuck.

LIBRAK350

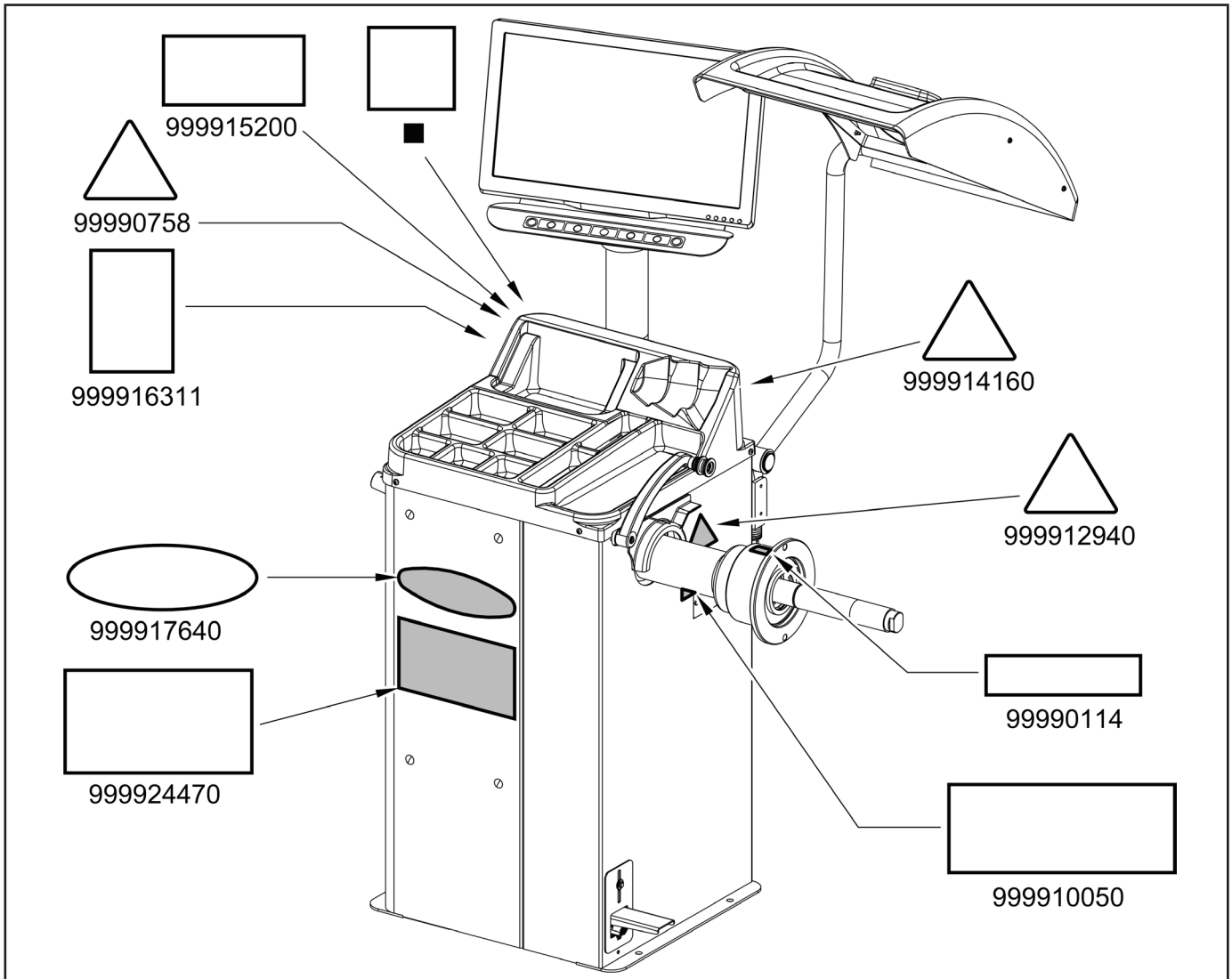
INFORMATION PLATE LOCATION DRAWING**Code numbers of plates**

99990114	<i>Arrow plate</i>
99990758	<i>Electric shock danger plate</i>
999910050	<i>Protection device use plate</i>
999912940	<i>Lifting plate</i>
999914160	<i>230V 50/60 Hz 1 Ph voltage plate</i>
999915200	<i>Serial number plate</i>
999916311	<i>Rubbish skip plate</i>
999917640	<i>Manufacturer plate</i>
999924470	<i>Machine nameplate</i>
■	<i>QR code plate</i>



IF ONE OR MORE PLATES DISAPPEAR FROM THE MACHINE OR BECOMES DIFFICULT TO READ. REPLACE IT AND QUOTE ITS/THEIR CODE NUMBER/S WHEN REORDERING.



SOME OF THE PICTURES AND/OR DISPLAY SCREEN PAGES PRESENT IN THIS MANUAL HAVE BEEN OBTAINED FROM PICTURES OF PROTOTYPES, THEREFORE THE STANDARD PRODUCTION MACHINES AND ACCESSORIES CAN BE DIFFERENT IN SOME COMPONENTS/DISPLAY SCREEN PAGES.

1.0 GENERAL INTRODUCTION

This manual is an integral part of the product and must be retained for the whole operating life of the machine.

Carefully study the warnings and instructions contained in this manual. It contains important instructions regarding **FUNCTIONING, SAFE USE and MAINTENANCE.**



KEEP THE MANUAL IN A KNOWN, EASILY ACCESSIBLE PLACE FOR ALL ACCESSORY OPERATORS TO CONSULT IT WHENEVER IN DOUBT.



THE MANUFACTURER DISCLAIMS ALL RESPONSIBILITY FOR ANY DAMAGE OCCURRED WHEN THE INDICATIONS GIVEN IN THIS MANUAL ARE NOT RESPECTED: AS A MATTER OF FACT, THE NON-COMPLIANCE WITH SUCH INDICATIONS MIGHT LEAD TO EVEN SERIOUS DANGERS.

1.1 Introduction

Thank you for preferring this wheel balancer. We feel sure you will not regret your decision.

This machine has been designed for use in professional workshops and stands out for its reliability and easy, safe and rapid operation. With just a small degree of maintenance and care, this wheel balancer will give you many years of trouble-free service and lots of satisfaction.

2.0 INTENDED USE

The machine described in this manual, and their different versions, is a wheel balancing machine for car and light transport, projected to be used exclusively to cancel out, or at least reduce to acceptable limits the vibrations of the wheels, by fitting counterweights, of suitable size and in specific positions to the wheels that are not correctly balanced.



EMPLOYING THIS MACHINE OUTSIDE THE USE DESTINATION IT HAS BEEN DESIGNED FOR (AS INDICATED IN THIS MANUAL) IS INAPPROPRIATE AND DANGEROUS.



THE MANUFACTURER CANNOT BE HELD RESPONSIBLE FOR ANY DAMAGE CAUSED BY IMPROPER, ERRONEOUS, OR UNACCEPTABLE USE.

2.1 Training of personnel

The machine may be operated only by suitably trained and authorized personnel.

Given the complexity of the operations necessary to manage the machine and to carry out the operations safely and efficiently, the personnel must be trained in such a way that they learn all the information necessary to operate the machine as intended by the manufacturer.



A CAREFUL READING OF THIS INSTRUCTION MANUAL FOR USE AND MAINTENANCE AND A SHORT PERIOD OF TRAINING WITH SKILLED PERSONNEL CAN BE AN ENOUGH PREVENTIVE PREPARATION.

3.0 SAFETY DEVICES



PERIODICALLY, AT LEAST MONTHLY, CHECK THE INTEGRITY AND THE FUNCTIONALITY OF THE SAFETY AND PROTECTION DEVICES ON THE MACHINE.

• Control logic disposition

Its function is to prevent the operator from dangerous mistakes.

• Main switch positioned on the rear of the machine

Its function is to disconnect machine electric supply.

• Protection guard

Its function is to protect the operator from possible projections of materials on the wheel during its spin. Wheel spinning is normally prevented if the wheel protection guard is raised (open). When the protection guard is open, this interrupts the circuit that triggers the motor and automatic start is prevented, including in the case of an error.



Press  key to stop wheel in emergency conditions.

3.1 Residual risks

The machine was subjected to a complete analysis of risks according to reference standard EN ISO 12100. Risks are as reduced as possible in relation with technology and product functionality.

Possible residual risks have been emphasized through pictorial representations and warnings which placing is indicated in "PLATE POSITIONING DRAWING" at page 6.

4.0 GENERAL SAFETY RULES



- Any tampering with or modification to the machine not previously authorized by the manufacturer exempts the latter from all responsibility for damage caused by or derived from said actions.
- Removing of or tampering with the safety devices or with the warning signals placed on the machine leads to serious dangers and represents a transgression of European safety rules.
- Use of the machine is only permitted in places free from **explosion** or **fire** hazard and in **dry places under cover**.
- Original spare parts and accessories should be used.



THE MANUFACTURER DENIES ANY RESPONSIBILITY IN CASE OF DAMAGES CAUSED BY UNAUTHORIZED MODIFICATIONS OR BY THE USE OF NON ORIGINAL COMPONENTS OR EQUIPMENT.

- The installation must be performed by qualified and authorized personnel in full compliance with the instructions given below.
- Ensure that there are no dangerous situations during the machine operating manoeuvres. Immediately stop the machine if it miss-functions and contact the assistance service of an authorized dealer.
- In emergency situations and before carrying out any maintenance or repairs, disconnect all supplies to the machine by using the main switch, placed on the machine itself, and unplugging the power supply.
- The machine power supply system must be equipped with an appropriate earthing, to which the yellow-green machine protection wire must be connected.
- Ensure that the work area around the machine is free of potentially dangerous objects and that there is no oil since this could damage the tyre. Oil on the floor is also a potential danger for the operator.
- UNDER NO CIRCUMSTANCES must the machine be used to spin anything but vehicle wheels. Bad locking can cause rotating parts to come loose, with potential damage to the machine and anything in the vicinity and injury to the operator.



OPERATORS MUST WEAR SUITABLE WORK CLOTHES, PROTECTIVE GLASSES AND GLOVES, AGAINST THE DANGER FROM THE SPRAYING OF DANGEROUS DUST, AND POSSIBLY LOWER BACK SUPPORTS FOR THE LIFTING OF HEAVY PARTS. DANGLING OBJECTS LIKE BRACELETS MUST NOT BE WORN, AND LONG HAIR MUST BE TIED UP. FOOTWEAR SHOULD BE ADEQUATE FOR THE TYPE OF OPERATIONS TO BE CARRIED OUT.



- The machine handles and operating grips must be kept clean and free from oil.
- The workshop must be kept clean and dry. Make sure that the working premises are properly lit. The machine can be operated by a single operator. Unauthorized personnel must remain outside the working area, as shown in **Fig. 3**. Avoid any hazardous situations. Do not use air-operated or electrical equipment when the shop is damp or the floor slippery and do not expose such tools to atmospheric agents.
- When operating and servicing this machine, carefully follow all applicable safety and accident-prevention precautions. The machine must not be operated by untrained personnel.



WHEN USING THE MODELS WITH WHEEL PNEUMATIC CLAMPING, DURING CHUCK OPENING/CLOSING OPERATIONS, BE EXTREMELY CAREFUL AND KEEP YOUR HANDS OR OTHER PARTS OF YOUR BODY AWAY FROM THE MOVING CHUCK.

5.0 PACKING AND MOBILIZATION FOR TRANSPORT



HAVE THE MACHINE HANDLED BY SKILLED PERSONNEL ONLY.

THE LIFTING EQUIPMENT MUST WITHSTAND A MINIMUM RATED LOAD EQUAL TO THE WEIGHT OF THE PACKED MACHINE (SEE PARAGRAPH "TECHNICAL SPECIFICATIONS").

The machine is packed partially assembled. Movement must be by pallet-lift or fork-lift trolley. The fork lifting points are indicated on the packing.

Fig. 2

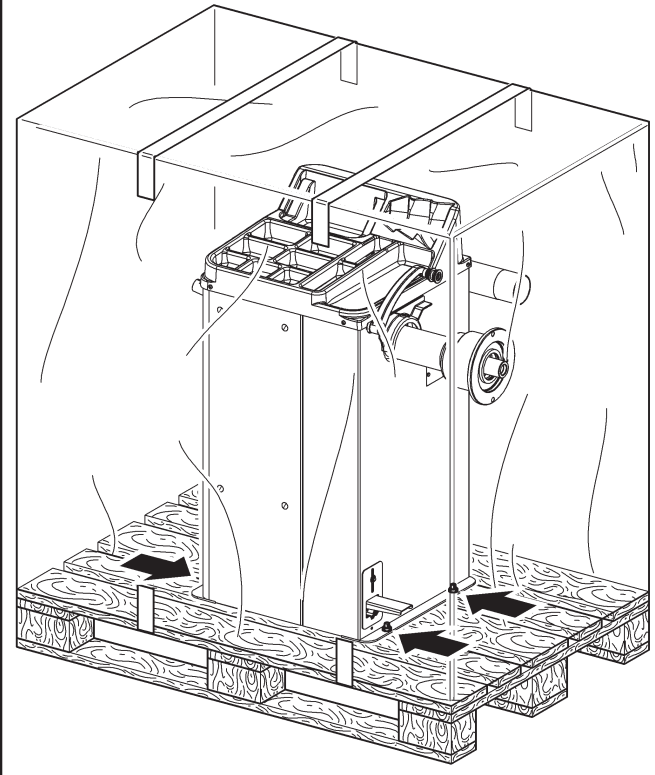

6.0 UNPACKING



DURING UNPACKING, ALWAYS WEAR GLOVES TO PREVENT ANY INJURY CAUSED BY CONTACT WITH PACKAGING MATERIAL (NAILS, ETC.).

The cardboard box is supported with plastic strapping. Cut the strapping with suitable scissors. Use a small knife to cut along the lateral axis of the box and open it like a fan.

It is also possible to unnailed the cardboard box from the pallet it is fixed to. After removing the packing, and in the case of the machine packed fully assembled, check that the machine is complete and that there is no visible damage.

If in doubt **do not use the machine** and refer to professionally qualified personnel (to the seller).

The packing (plastic bags, expanded polystyrene, nails, bolts, timber, etc.) should not be left within reach of children since it is potentially dangerous. These materials should be deposited in the relevant collection points if they are pollutants or non biodegradable.



THE BOX CONTAINING THE FIXTURES IS CONTAINED IN THE WRAPPING. DO NOT THROW IT AWAY WITH THE PACKING.

7.0 MOBILIZATION



THE LIFTING EQUIPMENT MUST WITHSTAND A MINIMUM RATED LOAD EQUAL TO THE WEIGHT OF THE MACHINE (SEE PARAGRAPH TECHNICAL SPECIFICATIONS). DO NOT ALLOW THE LIFTED MACHINE TO SWING.



NEVER LIFT THE MACHINE BY MEANS OF THE CHUCK.

If the machine has to be moved from its normal work post, the movement must be conducted following the instructions listed below.

- Protect the exposed corners with suitable material (Pluribol/cardboard).
- Do not use metallic cables for lifting.
- Make sure that the power supply is not connected.
- Place again the machine onto the original pallet with whom it was delivered.
- Use transpallet or fork-lift for handling.

8.0 WORKING ENVIRONMENT CONDITIONS

The machine must be operated under proper conditions as follows:

- temperature: 0° + 45° C
- relative humidity: 30 - 90% (dew-free)
- atmospheric pressure: 860 - 1060 hPa (mbar).

The use of the machine in ambient conditions other than those specified above is only allowed after prior agreement with and approval of the manufacturer.

8.1 Working area

Fig. 3

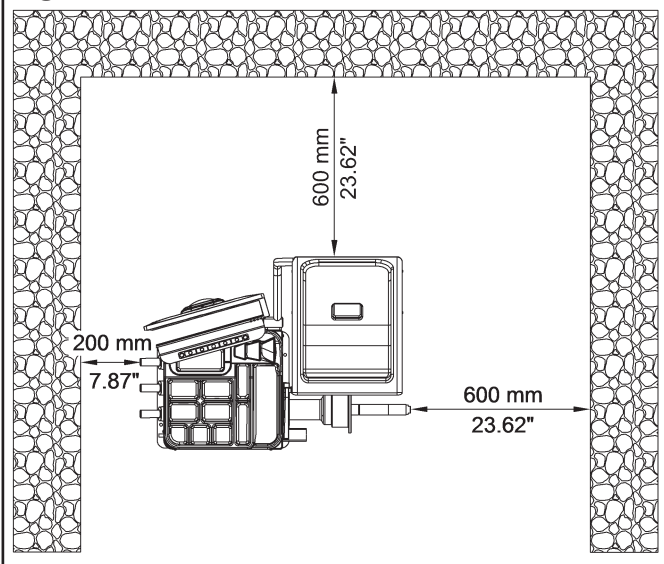

The location of the machine requires a usable space as indicated in **Fig. 3**. The positioning of the machine must be according to the distances shown. From the control position the operator is able to observe all the machine and surrounding area. He must prevent unauthorized personnel or objects that could be dangerous from entering the area. The machine must be secured to a flat floor surface, preferably of cement or tiled. Avoid yielding or irregular surfaces.

The base floor must be able to support the loads transmitted during operation.

This surface must have a capacity load of at least 500 kg/m².

The depth of the solid floor must be sufficient to guarantee that the anchoring bolts hold.

8.2 Lighting

The machine does not require its own lighting for normal working operations. However, it must be used in an adequately lit environment.

In case of poor lighting use lamps having total power of 800/1200 Watt.



USE THE MACHINE IN A DRY AND ADEQUATELY LIT PLACE, POSSIBLY INDOORS OR ANYWAY IN A ROOFED AREA, THIS PLACE MUST BE IN COMPLIANCE WITH APPLICABLE SAFETY REGULATIONS.

9.0 MACHINE ASSEMBLY



EACH MECHANICAL INTERVENTION MUST BE CARRIED OUT BY PROFESSIONALLY QUALIFIED STAFF.

After having freed the various components from the packing check that they are complete, and that there are no anomalies, then comply with the following instructions for the assembly of the components making use of the attached series of illustrations.

9.1 Anchoring system

The packed machine is fixed to the support pallet through the holes prearranged on the frame. Such holes can be used also to secure the machine to the ground, through floor anchor small blocks (excluded from supply). Before carrying out the definitive fixing, check that all the anchor points are laid down flat and correctly in contact with the fixing surface itself. If not so, insert shimming profiles between the machine and the fixing lower surface, as indicated in **Fig. 4**.



IT IS MANDATORY TO SECURE, IF WHEELS WEIGHING MORE THAN 30 KG ARE USED.

- Execute 4 holes with 10 mm diameter on the floor by the holes on the bottom floor;
- insert the small blocks (excluded from supply) into the holes;
- secure the machine to the ground with 4 M8x80 mm bolts (excluded from supply) (**Fig. 4 ref. 1**) (or with 4 8x80 mm stud bolts (excluded from supply)). Tighten the bolts with an approximate tightening torque of 70 Nm.

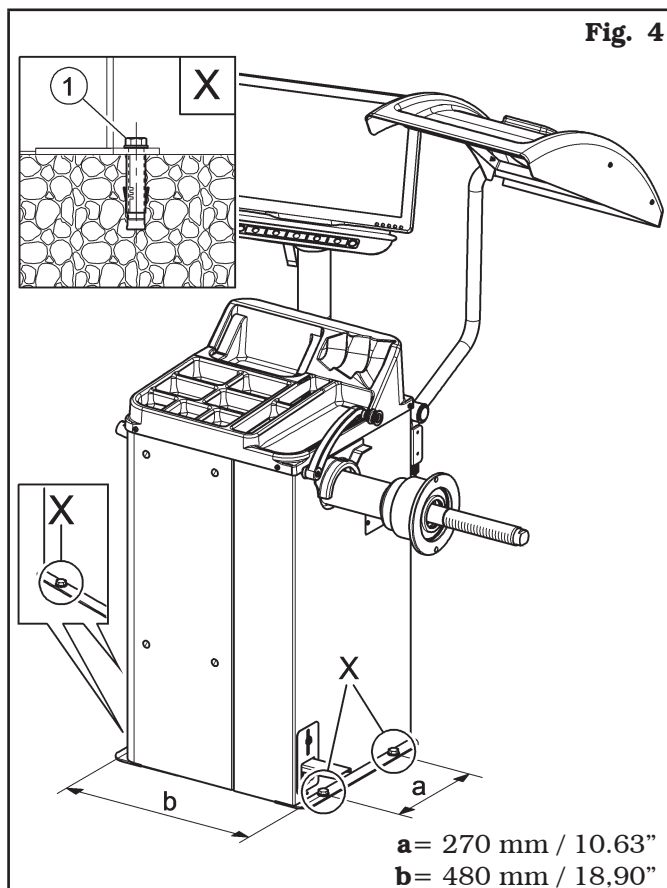

9.2 Assembly procedures

9.2.1 Fitting the shaft on the flange

Screw the shaft with an Allen wrench (Fig. 5 ref. 1) on the flange (Fig. 5 ref. 2).

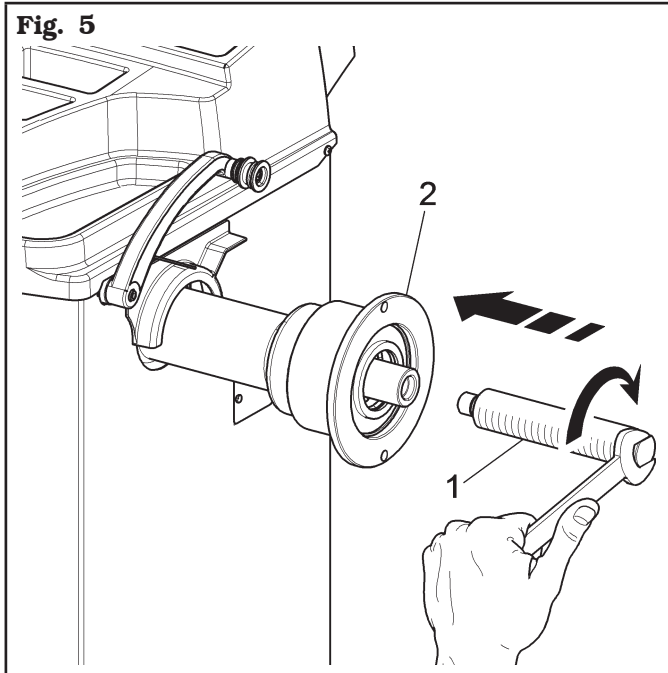

9.2.2 Fitting the protection guard (without width measuring device)

1. Screw the 3 bolts (Fig. 6 ref. 1) and the washers (Fig. 6 ref. 2) to the guard support (Fig. 6 ref. 3) in the special inserts positioned in the rear side of the frame, by means of an Allen wrench.
2. Fit the microswitch (Fig. 6 ref. 4) to the plate (Fig. 6 ref. 5) using bolts (Fig. 6 ref. 6), washers (Fig. 7 ref. 7) and nuts (Fig. 6 ref. 8).
3. Secure the plate complete with microswitch (Fig. 6 ref. 3) using bolts (Fig. 6 ref. 9), washers (Fig. 6 ref. 10) and nuts (Fig. 6 ref. 11).



PAY ATTENTION: MICROSWITCH LEVER (FIG. 6 REF. 4) MUST BE ADJUSTED BY SCREWDRIVER.

4. Mount the protection guard (Fig. 6 ref. 12) to the support (Fig. 6 ref. 3) interposing the washers (Fig. 6 ref. 13 and 14) and block it through the seeger (Fig. 6 ref. 15).
5. Fit the spring (Fig. 6 ref. 16) between the base of the support and the anchor pin.
6. Connect the 2 wires (Fig. 6 ref. 17) from inside the frame to the normally open (NO) microswitch contacts (Fig. 6 ref. 4).

Fig. 6

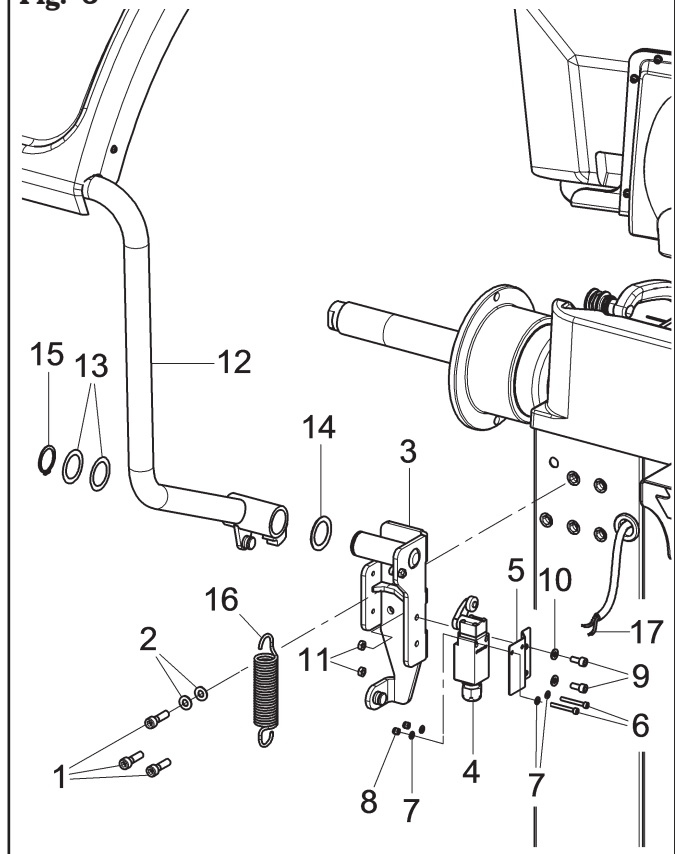

9.2.3 Monitor fitting

1. Remove the nuts (**Fig. 7 ref. 1**) and the washers (**Fig. 7 ref. 2**) from the bolts (**Fig. 7 ref. 3**). Fit the support pipe (**Fig. 7 ref. 4**), turned by 90°, and pay attention to the monitor and keyboard cables (**Fig. 7 ref. 5**) inside it. Insert the guard monitor (**Fig. 7 ref. 6**) into the monitor support (**Fig. 7 ref. 7**) and into the support pipe (**Fig. 7 ref. 4**), fit the monitor support (**Fig. 7 ref. 7**) and lock it through the nut (**Fig. 7 ref. 8**). Then screw the previously removed nuts and washers again.

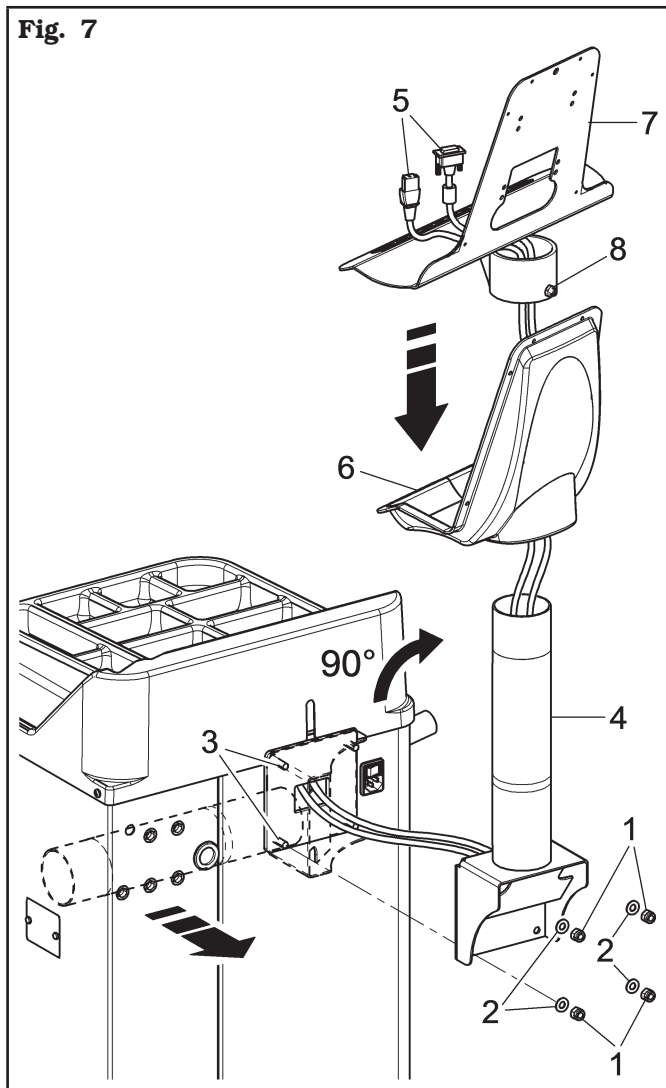

2. Connect the plugs on the power supply sockets and monitor signal. Connect the wiring of the keyboard.

3. Secure the monitor (**Fig. 8 ref. 1**) to the support (**Fig. 8 ref. 2**) with the bolts (**Fig. 8 ref. 3**) and the washers (**Fig. 8 ref. 4**) supplied.

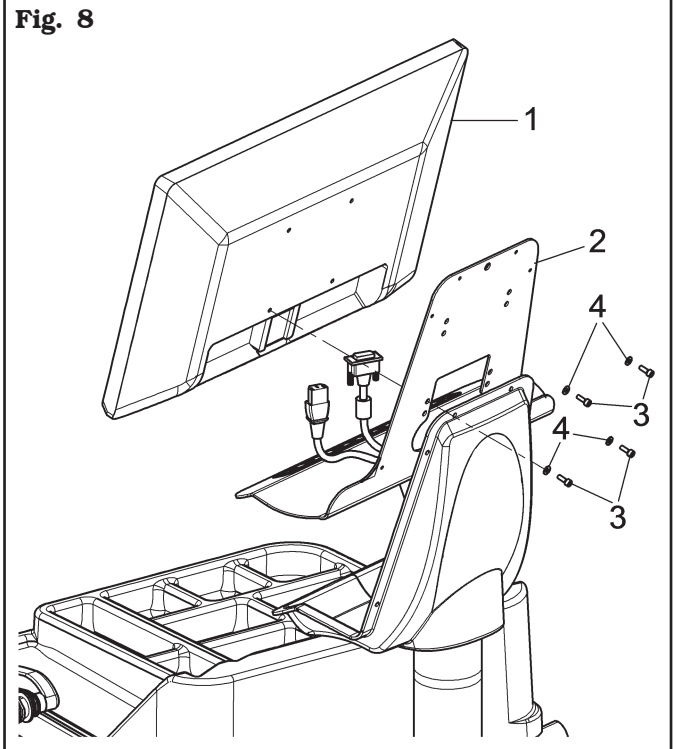

4. Mount the guard (**Fig. 9 ref. 1**) to the support (**Fig. 9 ref. 2**) with the 6 bolts (**Fig. 9 ref. 3**) and the washers (**Fig. 9 ref. 4**) supplied.

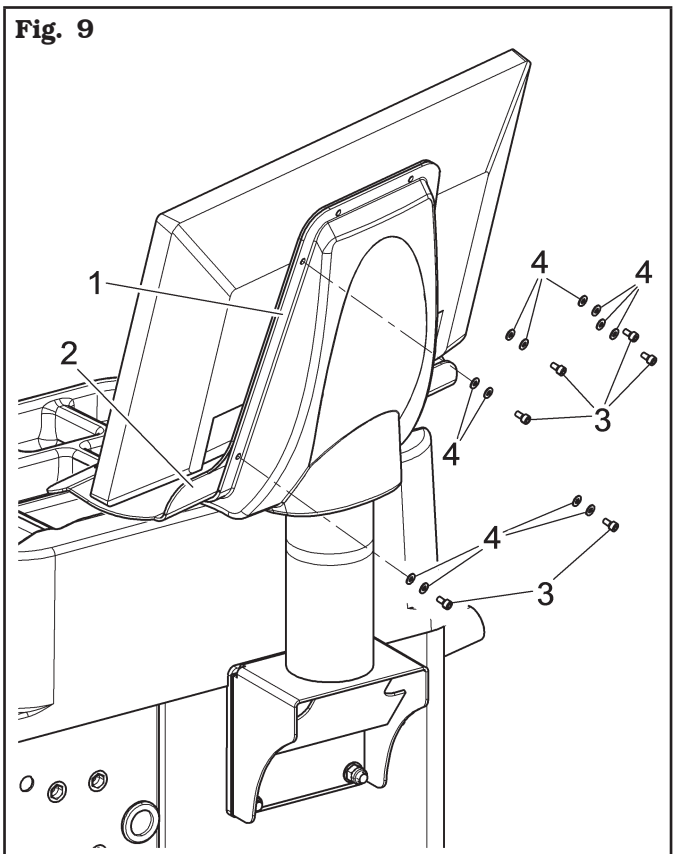

9.2.4 Fitting of external data gauge (optional)

1. Remove the protection guard (**Fig. 10 ref. 12**), if already present.
2. Remove the bolts (**Fig. 10 ref. 10**) and the washers (**Fig. 10 ref. 11**) from the wheel cover support, being very careful about holding the same support. Insert the gauge bracket (**Fig. 10 ref. 2**) into the lateral slot of the wheel cover support (see **Fig. 12 ref. A**).
3. If necessary, remove the microswitch (**Fig. 10 ref. 13**) so that it is possible to reach the securing bolts more easily.
4. Fit the fixing bolt (**Fig. 10 ref. 1**) and bolts (**Fig. 10 ref. 10**), previously removed, into the gauge bracket (**Fig. 10 ref. 2**); then screw the assembly to the threaded rivets placed on the rear part of the frame, without using the previously removed washers (**Fig. 10 ref. 11**). Secure bracket (**Fig. 10 ref. 4**) to the support guard (**Fig. 10 ref. 14**) with the bolts (**Fig. 10 ref. 8**) and the washers (**Fig. 10 ref. 9**). Lock the gauge arm (**Fig. 10 ref. 3**) to the brackets (**Fig. 10 ref. 2-4**) using the 2 bolts (**Fig. 10 ref. 5**), the washers (**Fig. 10 ref. 6**) and the nuts (**Fig. 10 ref. 7**), so that the shaft and the gauge arm are levelled (see **Fig. 11**).

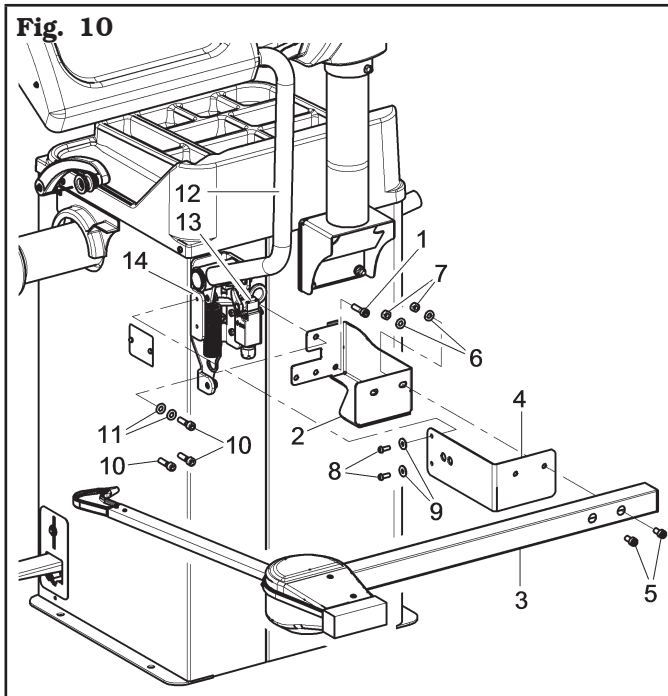

5. Also make sure the gauge tip (**Fig. 11 ref. 1**) is positioned APPROXIMATELY at the centre of the chuck.

Fig. 11

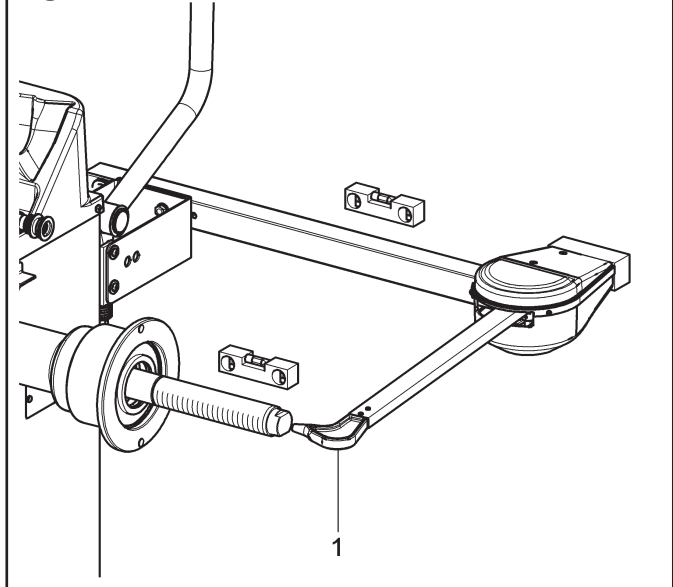

6. Connect connector (**Fig. 12 ref. 1**) of the cable coming from inside the machine to connector (**Fig. 12 ref. 2**) of the cable coming from the gauge arm. Fit the section of the cable with the connectors inside the arm (**Fig. 12 ref. 3**).
7. Fasten the cable with clamps.
8. Enable the external data gauge and carry out the device calibration.

Fig. 12

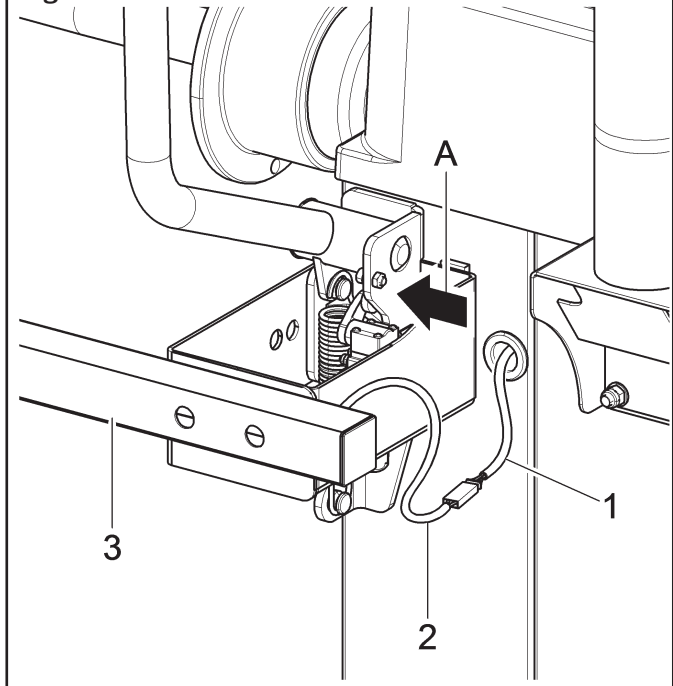

9. Mount microswitch again (**Fig. 10 ref. 13**), if previously removed.
10. Fit the protection guard (**Fig. 10 ref. 12**), as described in Par. 9.3.2..

10.0 ELECTRICAL CONNECTIONS



EVEN THE TINIEST PROCEDURE OF AN ELECTRICAL NATURE MUST BE CARRIED OUT BY PROFESSIONALLY QUALIFIED STAFF.



BEFORE CONNECTING THE MACHINE MAKE SURE THAT:

- THE MAIN POWER RATING CORRESPONDS TO THE MACHINE RATING AS SHOWN ON THE MACHINE PLATE;
- ALL MAIN POWER COMPONENTS ARE IN GOOD CONDITION;
- THE ELECTRICAL SYSTEM IS PROPERLY GROUNDED (GROUND WIRE MUST BE THE SAME CROSS-SECTION AREA AS THE LARGEST POWER SUPPLY CABLES OR GREATER);
- MAKE SURE THAT THE ELECTRICAL SYSTEM FEATURES A CUTOUT WITH DIFFERENTIAL PROTECTION SET AT 30 mA.

Connect the machine up to the mains by means of the 3-pole plug provided (110V - 230 V 1-phase) through the wall socket.

If the plug provided is not suitable for the wall socket, fit a plug that complies with local and applicable regulations. This operation must be performed by expert and professional personnel.



FIT A TYPE-APPROVED (AS REPORTED BEFORE) PLUG TO THE MACHINE CABLE (THE GROUND WIRE IS YELLOW/GREEN AND MUST NEVER BE CONNECTED TO ONE OF THE TWO PHASE LEADS).



MAKE SURE THAT THE ELECTRICAL SYSTEM IS COMPATIBLE WITH THE RATED POWER ABSORPTION SPECIFIED IN THIS MANUAL AND APT TO ENSURE THAT VOLTAGE DROP UNDER FULL LOAD WILL NOT EXCEED 4% OF RATED VOLTAGE (10% UPON START-UP).



FAILURE TO OBSERVE THE ABOVE INSTRUCTIONS WILL IMMEDIATELY INVALIDATE THE WARRANTY.

10.1 Electrical checks



BEFORE STARTING UP THE WHEEL-BALANCER, BE SURE TO BECOME FAMILIAR WITH THE LOCATION AND OPERATION OF ALL CONTROLS AND CHECK THEIR PROPER OPERATION (SEE PAR. "CONTROLS").



CARRY OUT A DAILY CHECK OF THE MAINTAINED ACTION CONTROLS CORRECT FUNCTIONING, BEFORE STARTING MACHINE OPERATION.

Once the plug/socket connection has been made, turn on the machine using the main switch (**Fig. 13 ref. 1**).

Fig. 13

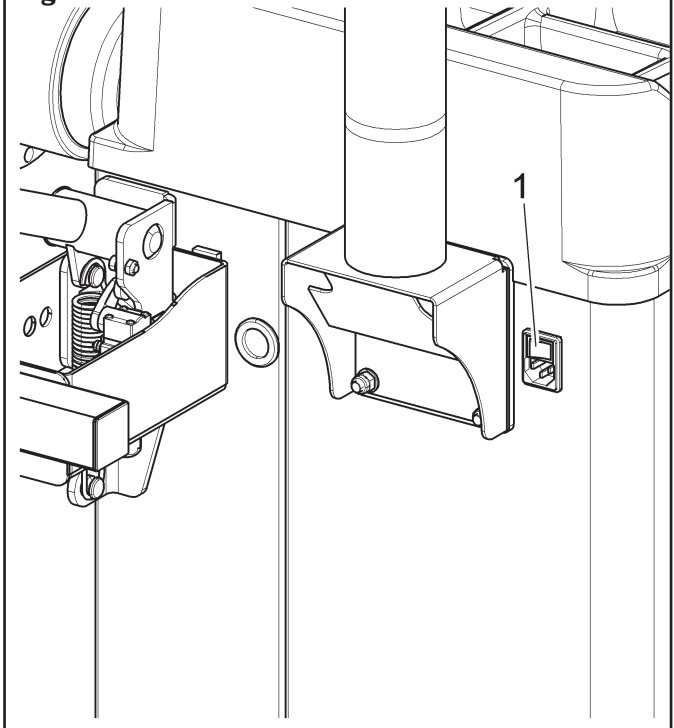

11.0 FITTING THE WHEEL ON THE SHAFT



To achieve perfect balancing, the wheel must be carefully and properly fitted on the shaft. Imperfect centring will inevitably cause unbalances.



WHAT IS MOST IMPORTANT IS THAT ORIGINAL CONES AND ACCESSORIES, SPECIALLY DESIGNED TO BE EMPLOYED WITH THE WHEEL BALANCERS, ARE USED.

Wheel fitting using the cones provided is illustrated below.

For alternative fittings, using optional accessories, refer to the special instructions provided separately.

11.1 Wheel assembly

1. Remove any type of foreign body from the wheel (**Fig. 14 ref. 3**): already-existing weights, stones and mud, and make sure the shaft (**Fig. 14 ref. 1**) and the rim centring area are clean before fitting the wheel on the shaft.
2. Carefully choose the cone (**Fig. 14 ref. 2**) most suitable for the wheel to be balanced. These accessories must be selected according to the shape of the rim. Carefully position the wheel (**Fig. 14 ref. 3**), fitting the cone (**Fig. 14 ref. 2**) on the shaft (**Fig. 14 ref. 1**) (otherwise this could seize) until this rests against the support flange (**Fig. 14 ref. 4**).
3. Fit the wheel with the inner side of the rim towards the wheel balancer and against the cone.

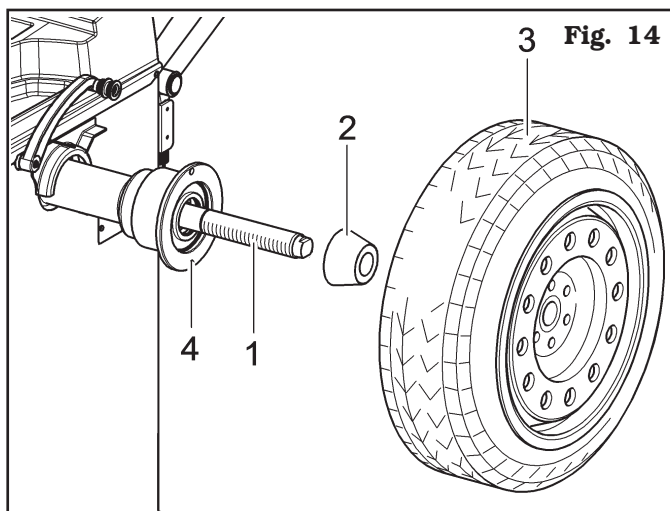

4. Fit the protection cap (**Fig. 15 ref. 1**) in the locknut (**Fig. 15 ref. 2**) and fasten against the wheel.

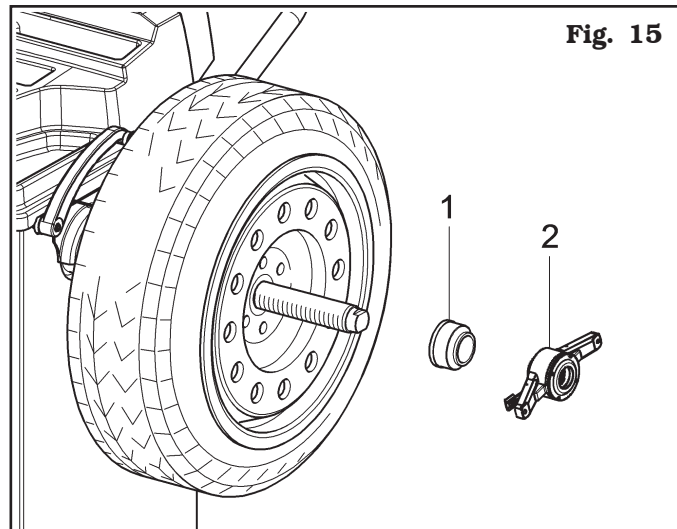

Some aluminium wheels, with very high centring, must be fitted with the cone outside the wheel.

5. Clean the shaft (**Fig. 16 ref. 1**) before fitting the wheel.
6. Fit the wheel (**Fig. 16 ref. 3**) with the inside of the rim towards the wheel balancer, until the wheel is up against the support flange (**Fig. 16 ref. 2**).

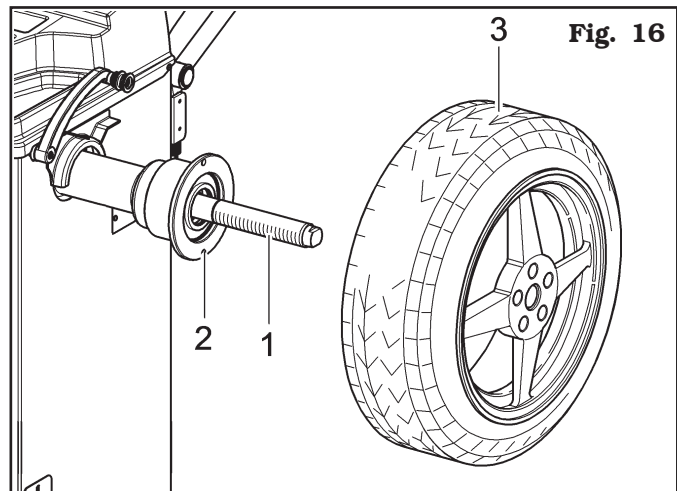

7. Fit the cone (**Fig. 17 ref. 3**) with the narrowest part turned towards the wheel.
8. Fit the pressure ring (**Fig. 17 ref. 1**) in the nut (**Fig. 17 ref. 2**) and fasten the cone (**Fig. 17 ref. 3**).

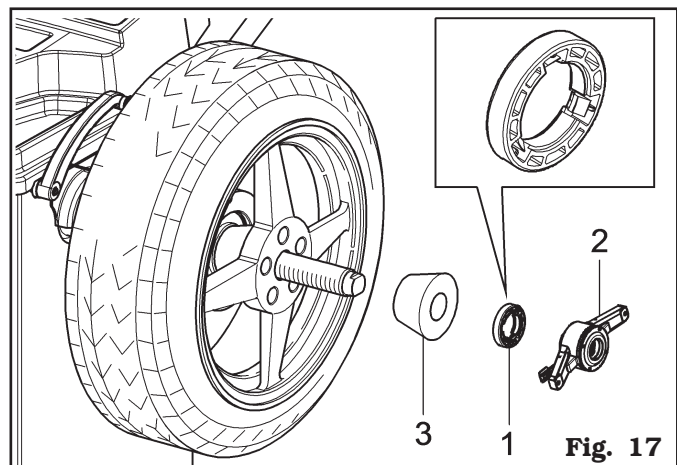



THE PRESSURE RING (FIG. 17 REF. 1) MUST BE MOUNTED WITH THE TEETH OR DISCHARGE SIDE TOWARDS THE RING-NUT (FIG. 17 REF. 2).

12.0 CONTROL PANEL

The wheel balancers are equipped with a control panel equipped with a keyboard to interact/operate the controls presented in graphical form on the monitor. On the monitor are displayed all the instructions for the correct wheel balancing, for example indicating where the operator shall fit adhesive or clip weights and the balancing mode and/or option used, as well as correct wheel rotation for inner/outer weights positioning.

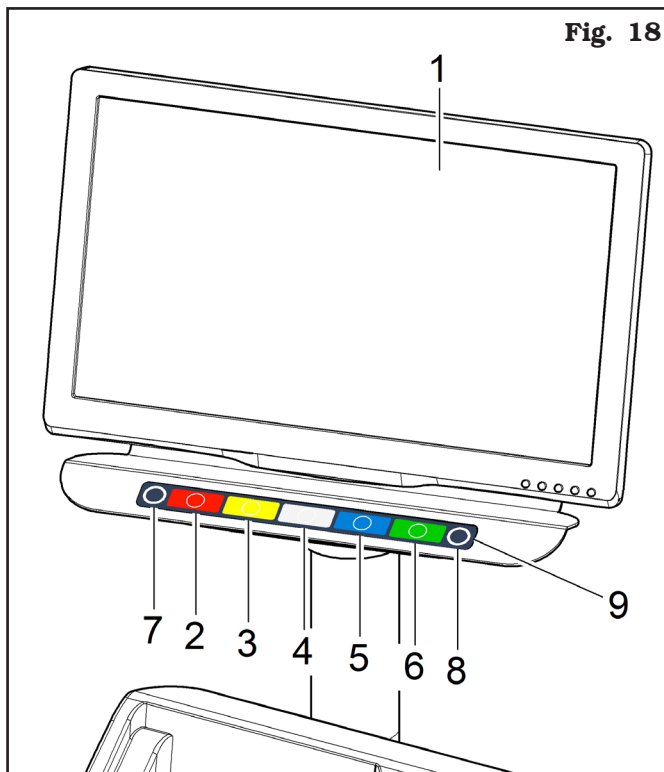

KEY

- 1 – Monitor
- 2 – Function push button (red)
- 3 – Function push button (yellow)
- 4 – Function push button (grey)
- 5 – Function push button (blue)
- 6 – Function push button (green)
- 7 – Previous page push button
- 8 – Next page/print push button
- 9 – Push button panel (keyboard with 7 keys)

13.0 WHEEL BALANCING

13.1 *Switching the machine on and off*

Press the "ON" switch (**Fig. 13 ref. 1**), located in the rear part of the equipment.

Wait a few seconds up to the complete loading of the operational program. The equipment is ready to operate when the main screen "Home" appears on the monitor.

Fig. 19

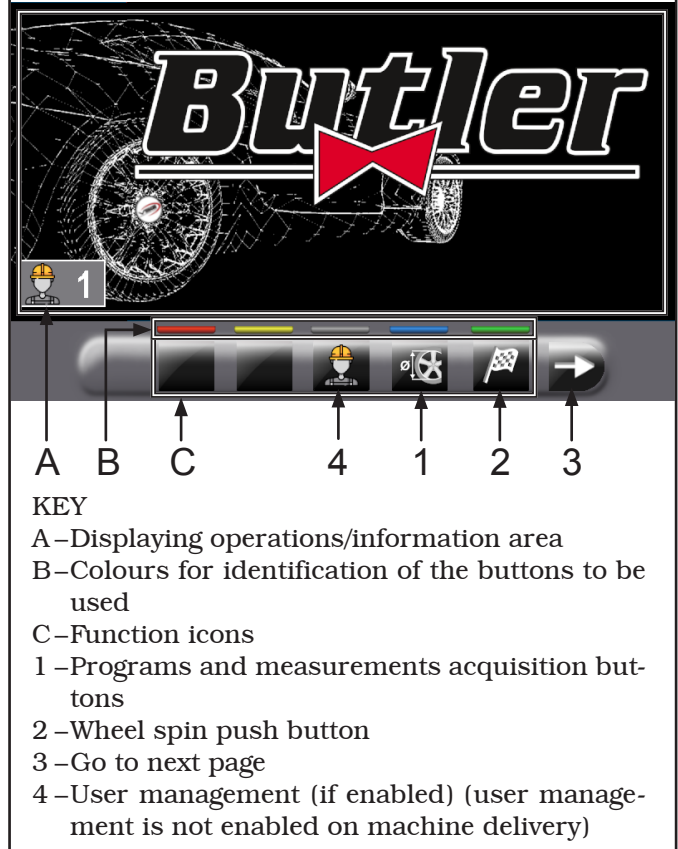

At the bottom of the main screen page and of each screen page described below, there will be coloured rectangles (**Fig. 19 ref. B**) located above function identification icons (**Fig. 19 ref. C**). These functions are activated by pressing the appropriate coloured button on the push-button panel (**Fig. 18 ref. 9**). Press the button (**Fig. 19 ref. 3**) to display a second page where you can access the "Technical assistance" menu and the "Run-out" menu (see **Fig. 20**).

Fig. 20

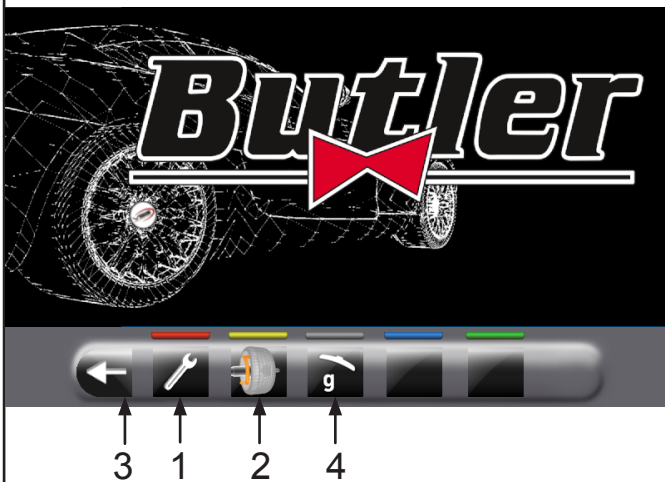

KEY

- 1 –User menu
- 2 –Run-out menu (visible only if active)
- 3 –Return to previous page
- 4 –Measurement unit setting.

The machine is supplied with "grams" option



enabled (see Chap. 14.0), so weights will be displayed only in grams and no icons will be displayed onto push button 4.



In order to modify the measurement unit carry out the following procedure: if "ounce" option



is activated from user menu (see Chap. 14.0), "ounce" weight displaying mode is set,

and push button  will be displayed. Press

the button  to set machine weight display in grams and on the screen will be displayed

icon . Press the button  to set machine weight display in ounces and on the screen

will be displayed icon .

In order to turn off the machine, simply press the "OFF" main switch (**Fig. 13 ref. 1**).



WHEN THE EQUIPMENT IS TURNED OFF LOSES ALL THE MEASUREMENTS AND THE STORED DATA (SIZE, SPINS, USERS, ETC ...). AT RESTARTING,

PRESSING THE BUTTON  (IN THE CASE HAVE NOT YET BEEN STORED ON THE NEW MEASURES AFTER THE SWITCHING ON), THE MACHINE DOES NOT PERFORM ANY OPERATION.

13.2 Balancing programs setting

The setting of the balancing programs can be performed in two ways:

- through the gauge arm (rapid setting);
- through "Measurement being acquired" screen, ap-

pearing when the  button is pressed (**Fig. 19 ref. 1**).

The setting modes are completely different even if they allow to reach the same result (but with different times).

13.2.1 Programs rapid setting and measurements through distance-diameter caliper arm

The use of the distance-diameter caliper arm allows the rapid automatic wheel balancing program and the measures entry. From page "Home":

- bring into contact the weights fitting gripper with the inner part of the rim (1 contact only) to select the program "STATIC" (see Fig. 21).

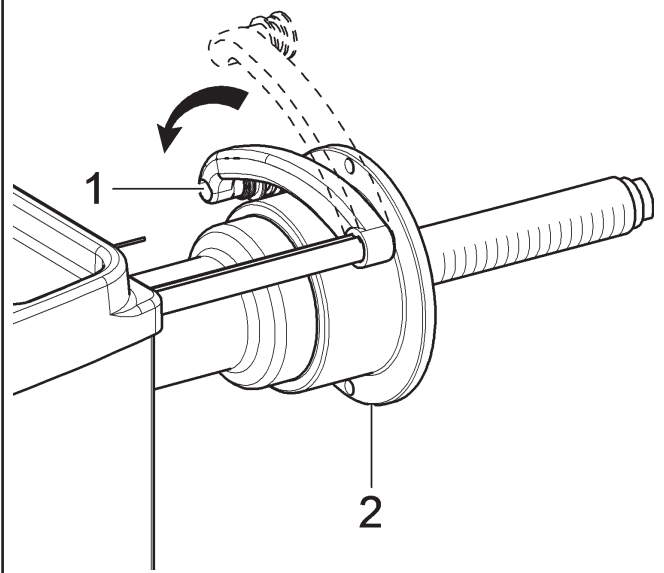

Fig. 21



REPEATEDLY BRINGING THE GAUGE ARM (FIG. 22 REF. 1) IN CONTACT WITH THE CHUCK (FIG. 22 REF. 2), THE PROGRAM WILL CYCLE FROM "STATIC" TO "STATIC 1" TO "STATIC 2" RETURNING THEN AT THE BEGINNING.

Fig. 22



- bring into contact the weights fitting gripper with the inner part of the rim (2 contact points) (see Fig. Fig. 21) to select "ALU-S" program.



REPEATEDLY BRINGING THE CALIPER ARM (FIG. 22 REF. 1) IN CONTACT WITH THE CHUCK (FIG. 22 REF. 2), THE PROGRAM WILL CYCLE FROM "ALU-S" TO "ALU-S1" TO "ALU-S2", RETURNING THEN AT THE BEGINNING.



WHENEVER THE DISTANCE-DIAMETER CALIPER AND/OR THE EXTERNAL DATA GAUGE (SEE FIG. 23(IF ANY) IS KEPT IN POSITION FOR A FEW SECONDS AGAINST THE RIM (UNTIL THE MACHINE MAKES AN APPROPRIATE SOUND NOTIFICATION), THE POSITION IS STORED AND THE VALUES MEASURED IN THE PRE-ARRANGED FIELDS IN THE SELECTED WHEEL BALANCING PROGRAM ARE LOADED.

Fig. 23

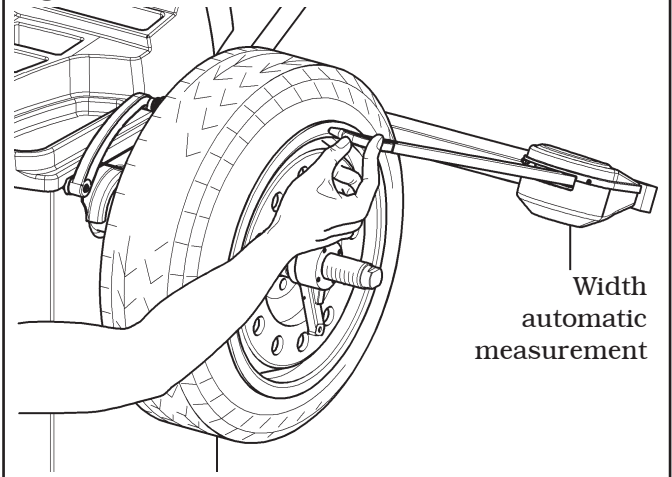

- After entering all the required measures, you can spin

the wheel by pressing the button  and closing the protective guard.

• **Measuring procedure of electronic RUN-OUT with the distance-diameter caliper arm.**

The electronic RUN-OUT measuring device is useful to check if the rim has some imperfections.

To access the screen to choose the rim control mode, proceed as follows:

- from the "Home" page, press the button



(Fig. 24 re. 1) and then the button



(see Fig. 25 ref. 1).

Fig. 24

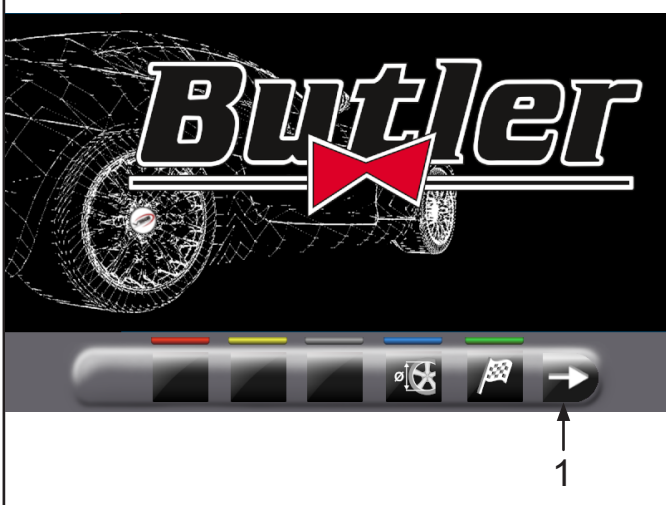
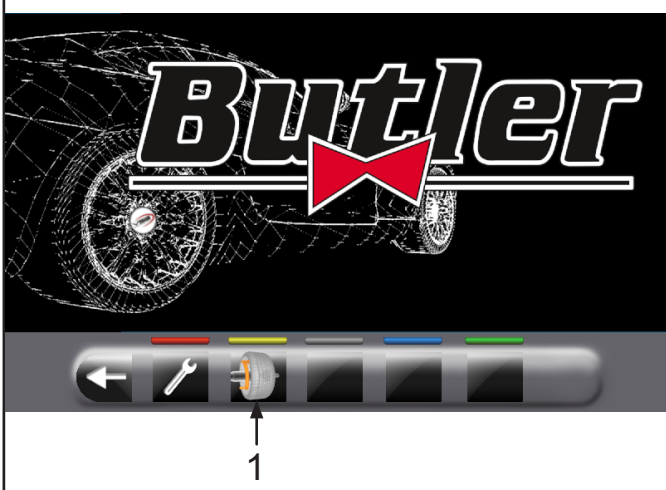
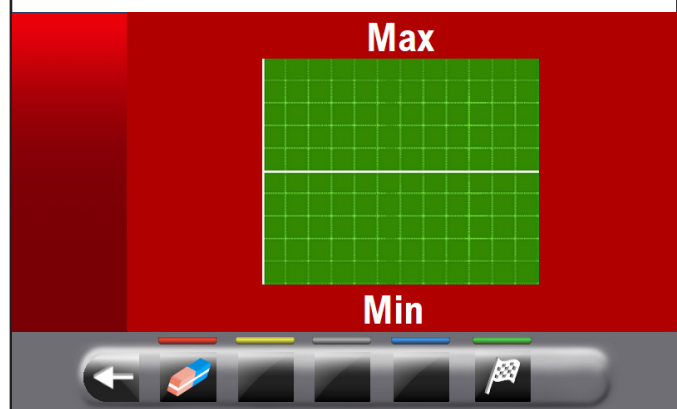

Fig. 25



- The following screen page will appear on the monitor:

Fig. 26



- Place the distance-diameter caliper grippers (Fig. 27 ref. 1) in contact with the rim.

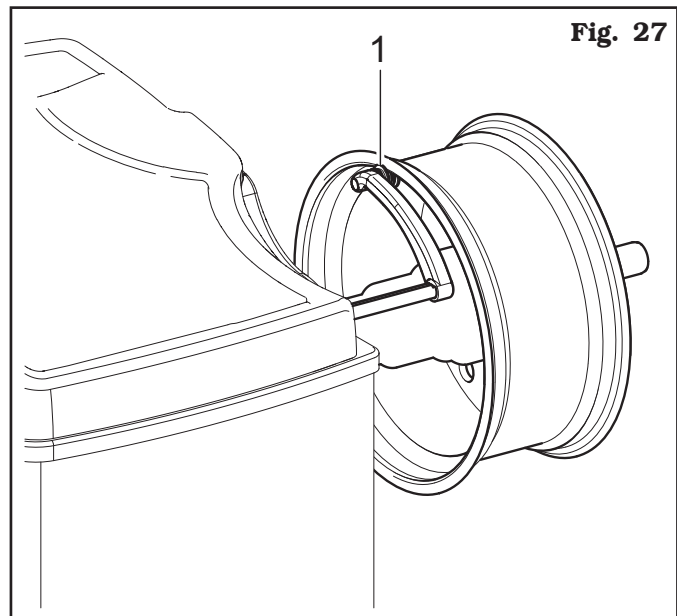

Fig. 27

Press the green button on the monitor  to start the rim analysis procedure. The circle starts to spin at low speed (30 rpm) and at the end of the measurement the eccentricity graph appears, as shown in the Fig. 28.

Fig. 28



KEY

- 1 - Fundamental sine wave (fuchsia-coloured-graph)
- 2 - Graph of detected eccentricity (blue)
- 3 - Slider that indicates the current position of the rim ("12 o'clock") (red)
- 4 - Value in mm of the highest peak of imperfection detected on the rim
- 5 - Value in mm of imperfection of the rim at the current position
- 6 - Value in mm of the lowest peak of imperfection detected on the rim
- 7 - Graph deleting button

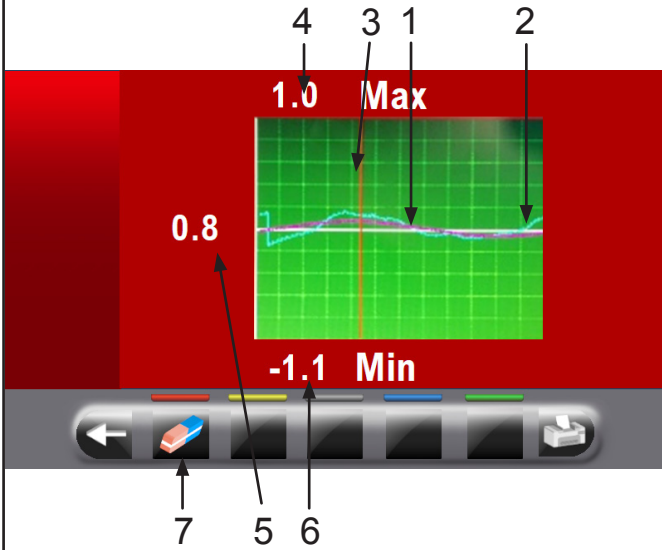
The blue graph (Fig. 28 ref. 2) represents exactly the geometric shape of the rim. The more the circle is round and linear, the more the graph is flat, unlike the more the circle has deficiencies, the more the graph is large.



You can follow the eccentricity in the graph by manually turning the rim, the red-coloured-slider (Fig. 28 ref. 3), indicates the position of the rim in "12 o'clock" position.

13.2.2 Programs setting through "Measurements acquisition" screen page

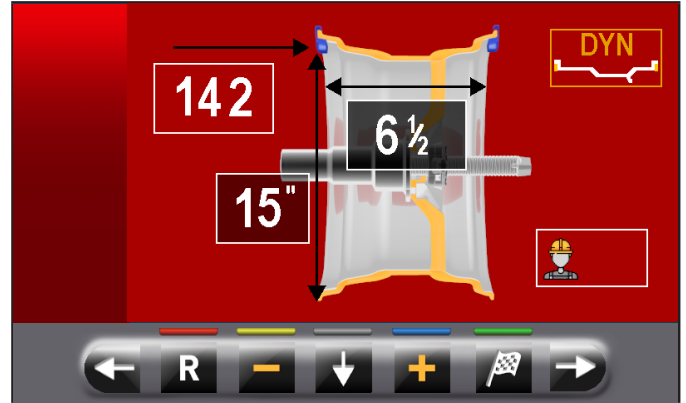

From the "Home" page, press the (Fig. 19 ref. 1) button to display "Measurements acquisition" screen page below:



PRESS THE BUTTON  (Fig. 19 ref. 1) **TO DISABLE THE AUTOMATIC FUNCTIONS FOR THE SELECTION OF THE BALANCING PROGRAM OF DISTANCE-DIAMETER CALIPER ARM, DESCRIBED IN PAR. 13.2.1. TO BE ABLE TO REUSE THE AUTOMATIC FUNCTION TO SELECT THE WHEEL BALANCING PROGRAM WITH GAUGE ARM, IT IS NECESSARY TO RETURN TO "HOME" PAGE, BY PRESSING THE**  **BUTTON**.

The selection of the wheel balancing program is possible in 2 ways:

- with highlighted program (yellow) by pressing the



until you see the desired program. With this mode only the 11 standard programs can be selected (DYN, ALU-S, ALU-S1, ALU-S2, STAT, STAT-1, STAT-2, ALU-1, ALU-2, ALU-3, ALU-4).





IF THE PROGRAM NAME IS NOT HIGHLIGHTED (YELLOW), PRESS  **REPEATEDLY UNTIL THE ABOVE CONDITION IS REACHED.**



- Press the button  to display the following programs selection screen page:



Use the arrows  and/or  to select the wished mode (yellow). In this mode you can select the 11 standard programs (listed above) and special programs (PAX360, PAX420, PAX460, PAX700).



AFTER YOU HAVE SELECTED THE DESIRED PROGRAM, USE THE DISTANCE-DIAMETER CALIPER AND/OR THE EXTERNAL DATA GAUGE (IF ANY) TO DETECT THE MEASURES REQUIRED BY THE PROGRAM.



WHENEVER THE DISTANCE-DIAMETER CALIPER AND/OR THE EXTERNAL DATA GAUGE (SEE FIG. 23(IF ANY) IS KEPT IN POSITION FOR A FEW SECONDS AGAINST THE RIM (UNTIL THE MACHINE MAKES AN APPROPRIATE SOUND NOTIFICATION), THE POSITION IS STORED AND THE VALUES MEASURED IN THE PRE-ARRANGED FIELDS IN THE SELECTED WHEEL BALANCING PROGRAM ARE LOADED.

- After entering all the required measures, you can spin



the wheel by pressing the button  and closing the protective guard.

13.3 Indicative display of points where to detect measures/to fit weight



IT IS VERY IMPORTANT TO REMEMBER THE POINTS SELECTED FOR MEASUREMENT INSIDE THE RIM SINCE DURING THE WEIGHTS FITTING WITH FIXED LASER YOU WILL NOT HAVE ANY OTHER REFERENCE EXCEPT FOR THE CROSS LINE ON THE RIM, GENERATED BY THE LASER ITSELF. THE POSITIONING IN DEPTH WILL BE AT THE DISCRETION OF THE OPERATOR.

Depending on the type of program selected, the machine shows on the monitor the guideline points where to take measures and, consequently, where you must apply weights (**Fig. 29 ref. 4-5**).

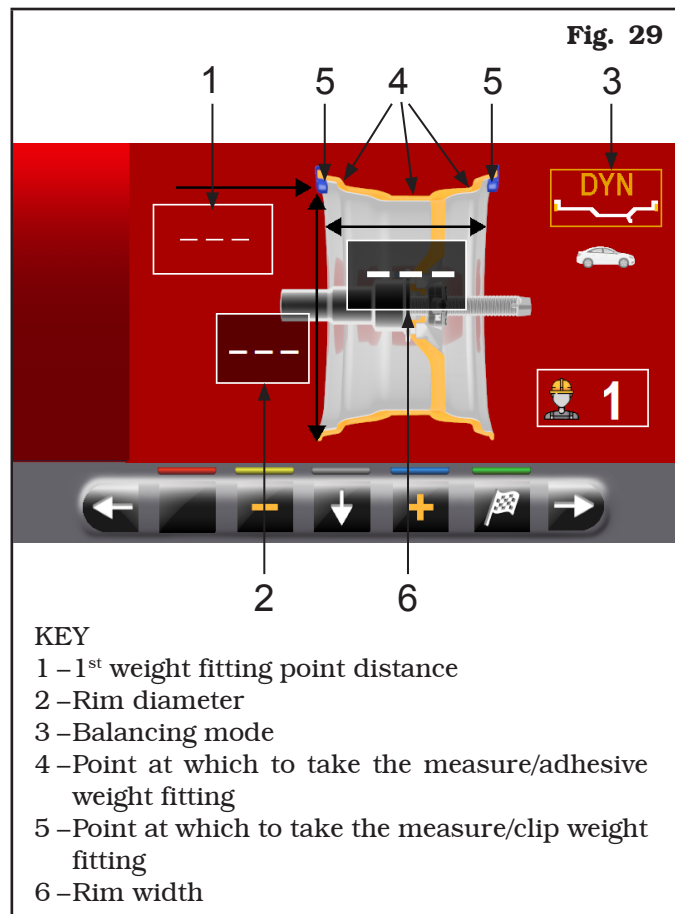

THE MORE THE POINTS CHOSEN FOR THE PROBING ARE DISTANT FROM EACH OTHER THE MORE THE BALANCING WILL BE EFFEC-TIVE.

13.3.1 Weights positioning

The monitor displays when it is absolutely necessary that the weight is applied at "12 o'clock" position. Pay particular attention to the weights identification icons



since if the following words are displayed, then the icon corresponding weight has to be applied at "12 o'clock" position (typical of STAT-2, ALU-S2 programs).





IF ALL MEASURES REQUIRED BY THE PROGRAM HAVE NOT BEEN TAKEN/INSERTED, THE MACHINE DOES NOT ALLOW THE WHEEL SPIN TO DETECT THE UNBALANCE.

13.4 Displaying the active/modifiable field

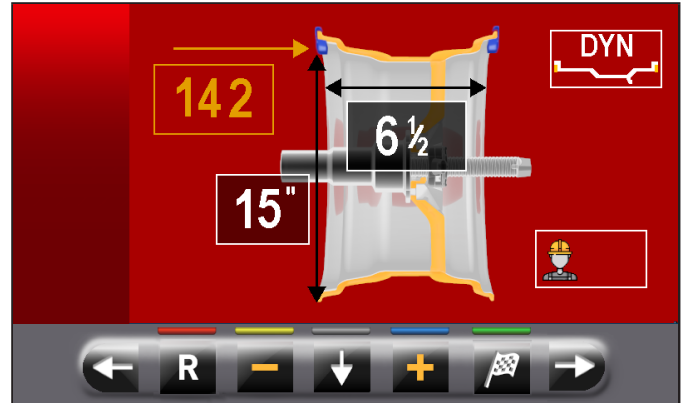
During the various phases of measures detection, the active field turns yellow.



Pressing the buttons  or  you can change the value and/or program inside the active field. To change the selected active field, simply press the but-

ton  until the desired field is coloured yellow.



THE SELECTION OF THE ACTIVE FIELD IS DONE BY HIGHLIGHTING THE FIELDS IN A CLOCKWISE DIRECTION.

NORMALLY DURING THE DETECTION OF MEASUREMENTS, THE 1ST ACTIVE FIELD WILL BE THE ONE FOR THE SELECTION OF THE PROGRAM.

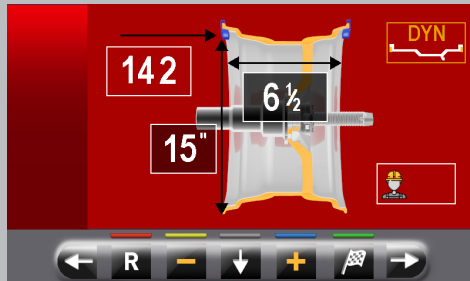

THERE IS A CASE, HOWEVER, IN WHICH THE 1ST ACTIVE FIELD WILL BE THE RIM WIDTH.

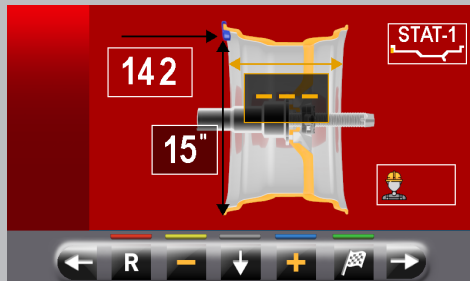

THIS CASE WILL OCCUR ONLY IF FROM "HOME" PAGE IS DETECTED ONLY ONE MEASUREMENT INSIDE THE RIM. THE PROGRAM WILL AUTOMATICALLY SET TO "STATIC" BUT IT WILL MAKE IT POSSIBLE (IN CASE OF ABSENCE OF EXTERNAL DATA GAUGE) TO MANUALLY ENTER RIM WIDTH AND TO QUICKLY SWITCH TO THE PROGRAM "DYNAMIC".



13.5 Wheel balancing screen page description

After executing the spin of the wheel, the monitor displays a series of important information that helps the operator in his operations and subsequent choices.

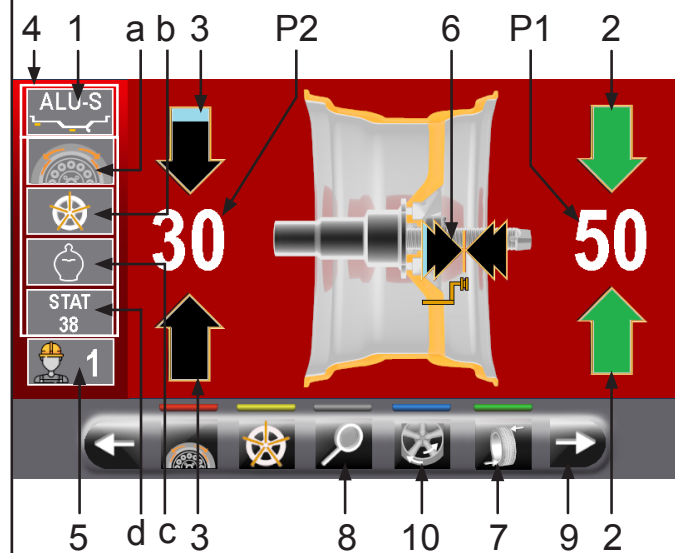
Fig. 30



KEY

- 1 – Measures used by the program to perform the spin and detect the values in P1 - P2
- P1– Weight to be fitted on rim outer side
- P2– Weight to be fitted on rim inner side
- 2 – Wheel placed to fit the weight on wheel outer side (arrows both green)
- 3 – Wheel not placed to fit the weight on wheel inner side (blue/black arrows)
- 4 – Wheel balancing suggestions
- 4a– SPLIT Program (Clip weights program)
- 4b– SPOKES Program (program with adhesive weights)
- 4c– ECO-WEIGHT Program
- 4d– STATIC Program
- 5 – N° user (if selected)
- 6 – Arrows indicating the weight fitting point with distance-diameter caliper arm
- 7 – Wheel repositioning button for weights fitting
- 8 – Display of the weight with the maximum resolution of 1 g / 0,05 oz
- 8a– Display of the weights in grams 
- 8b– Display of the weights in ounces/grams 
- 9 – By pressing the button  you will see the following page where you can select one of the programs suggested by the machine.
- 10– MATCHING program

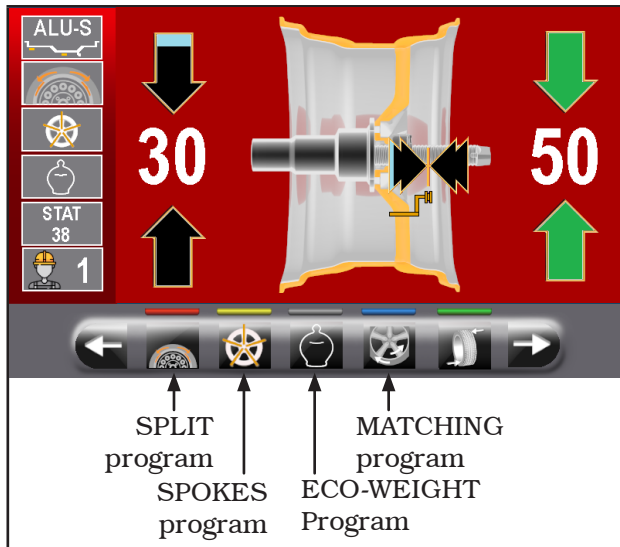

IF THE GUARD AND REPOSITIONING FUNCTION ARE DISABLED, ON THE BUTTON IN POS. 7 FIG. 30, YOU WILL SEE THE  ICON THAT WILL ALLOW WHEEL SPIN WITHOUT RETURNING TO THE PREVIOUS PAGE. THE POSITIONING OF THE WHEEL FOR THE APPLICATION OF THE WEIGHTS MUST BE DONE MANUALLY.

8a-Display of the weights in GRAMS

Set the unit of measurement for weights

display to GRAMS  (see Par. 14.1 "Options menu").

On the following screen page:

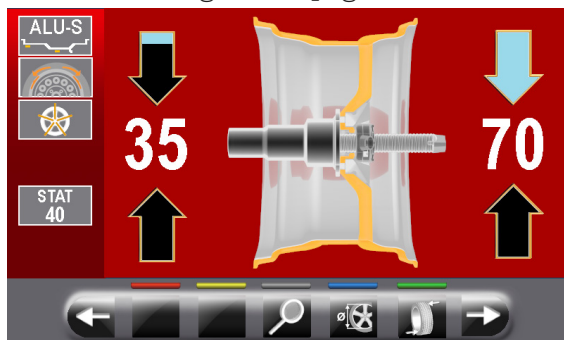

press the button  to display the weight with maximum resolution (1g) to be fitted on the wheel, expressed in grams.

The following screen will appear on the monitor:

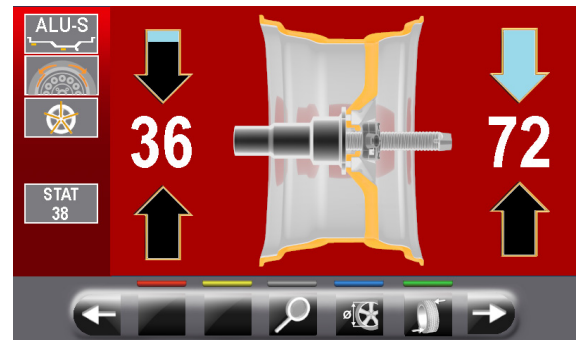

Press again the button  to display the approximated weight to be fitted to the wheel, expressed in grams.

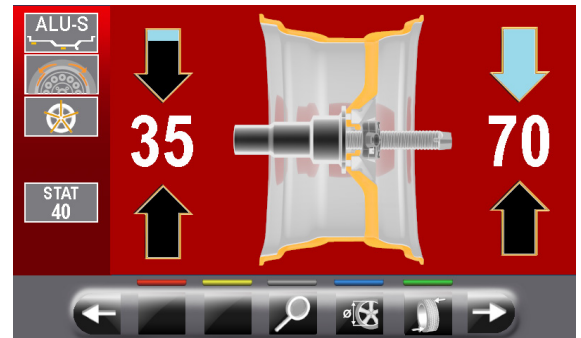

7b-Display of the weights in OUNCES/GRAMS
Set the unit of measurement for weights

display to OUNCES/GRAMS  (see Par. 14.1 "Options menu").

On the following screen page:

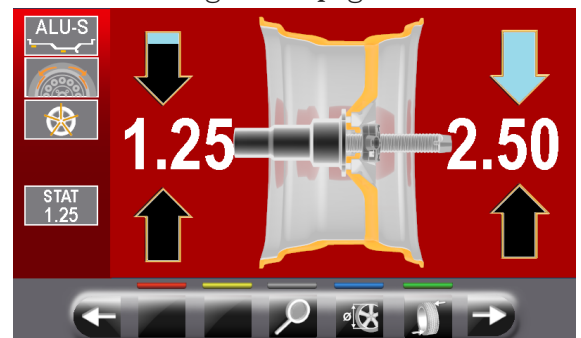

press the button  to display the weight with maximum resolution (0.05 oz) to be fitted on the wheel, expressed in ounces.
The following screen will appear on the monitor:

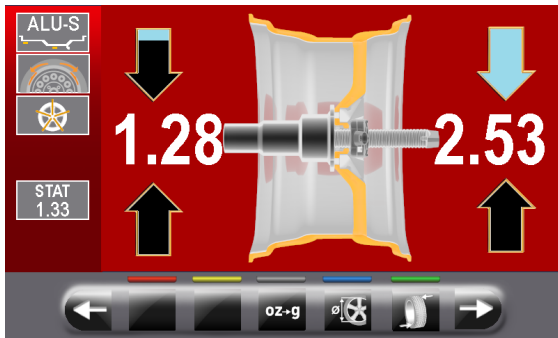

Press the button **oz-g** to set the display of the weights to be fitted on the wheel in grams. The following screen will appear on the monitor:

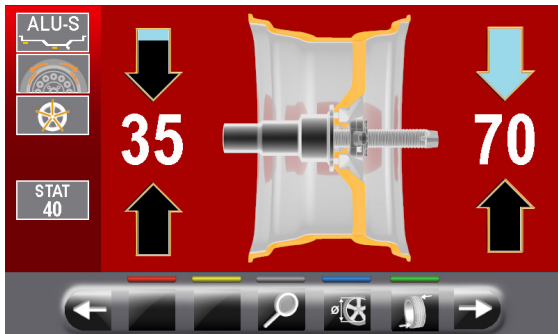

Press the button  to display the weight with maximum resolution (1g) to be fitted on the wheel, expressed in grams. The following screen will appear on the monitor:

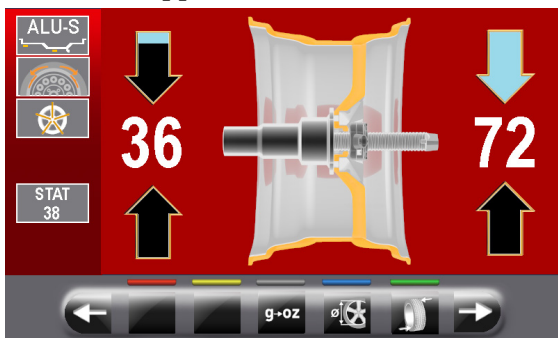

Press the button **g-oz** to set the display of the weights to be fitted again in ounces. The following screen will appear on the monitor:



13.5.1 Balancing mode

The machine has the ability to perform the wheel balancing (weights fitting) in 4 different ways:

- using the distance-diameter caliper arm with weights fitting grippers;
- weights fitting at "6 o'clock" (without the use of laser emitter).

• **Weights fitting with distance-diameter caliper arm.**

1. Place the adhesive weight on the arm grippers.

Fit the adhesive weight in the pliers of the gauge rod



2. Pull out the gauge until the arrows (**Fig. 30 ref. 6**) both turn green.

3. Rotate the gauge arm until the weight touches the rim.

Fit weight on the position where pliers touches the wheel



4. Bring the distance-diameter caliper arm in resting position, after having led it towards the chuck to unlock it from the position of weight application.



5. Press the button to change the weight fitting side.
6. Proceed in the same way as described in points 1-2-3.



BEFORE REMOVING THE DIAMETER-DISTANCE CALIPER, PRESS THE BRAKE PEDAL AND HOLD IT DOWN UNTIL THE WEIGHT HAS NOT BEEN APPLIED, ENSURING IN THIS WAY THAT, DURING THESE PHASES, THE WHEEL CAN NOT ROTATE.

- **Weights fitting at "6 o'clock" (without the use of laser emitter).**



TO USE THIS MODE, IT IS NECESSARY THAT THE RELEVANT FUNCTION IS ENABLED



ON THE MENU "OPTIONS" DESCRIBED IN PAR. 14.1.



TO USE THIS WEIGHT APPLICATION MODE THE OPERATOR MUST REMEMBER THE PRECISE POINT WHERE THE MEASUREMENT WAS TAKEN WITH THE DISTANCE-DIAMETER CALIPER ARM.



USING THIS MODE, THE MACHINE ALLOWS YOU TO APPLY ANY ADHESIVE WEIGHTS THAT WOULD BE APPLIED WITH DISTANCE/DIAMETER CALIPER AT "6 O'CLOCK". IF, AFTER YOU ENABLE THIS MODE, ON BALANCING PROGRAM APPEARED AGAIN THE

H12

ICON (ONLY IN THIS CASE) THE ADHESIVE WEIGHT WILL BE APPLIED TO "12 HOURS".

At the end of the spin, the wheel stops in place to apply the weight at "6 o'clock". The positioning of the weight (s) in depth shall be at the discretion of the operator, depending on where remembers taking the measure.



BE SURE TO APPLY THE (INTERNAL OR EXTERNAL) WEIGHT AS INDICATED BY THE 2 GREEN ARROWS (Fig. 30 ref. 2 or 3) ON THE CORRESPONDING MONITOR SCREEN.

13.6 Use of machines with disabled automatic data gauge

The entry of diameter, width and distance measures of the machine rim must be performed manually. The reading of these measures can be made as follows:

- visual readout on caliper graduated scale (distance);
- values readout on rim (diameter and width);
- width value detection with manual caliper (width) (see **Fig. 31**).

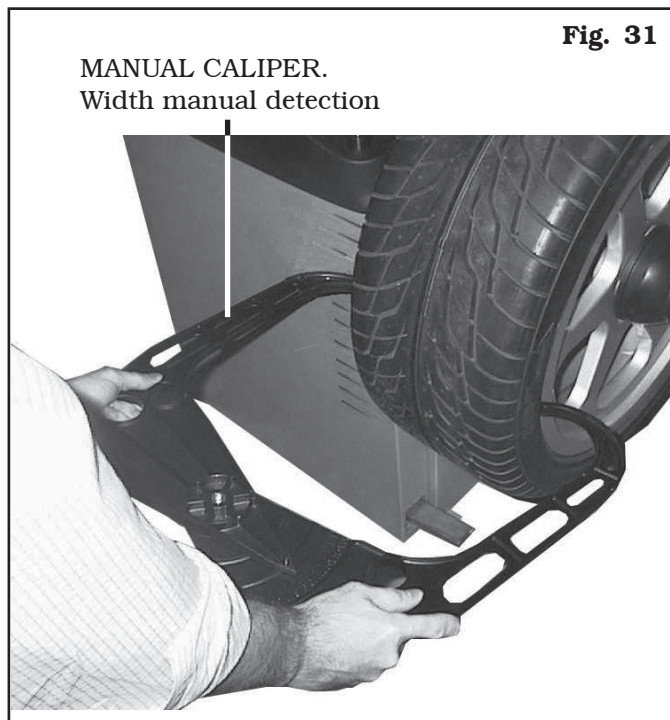

Fig. 31

13.6.1 Manual setting of wheel dimensions

In case the operator wants to edit and/or manually enter the wheel dimensions, proceed as follows:

- from the desired measurement mode screen, press

the button  until highlighting with yellow the field to modify/edit;

- press the buttons  or  until reaching the desired value;

- press button  to shift to the next value.

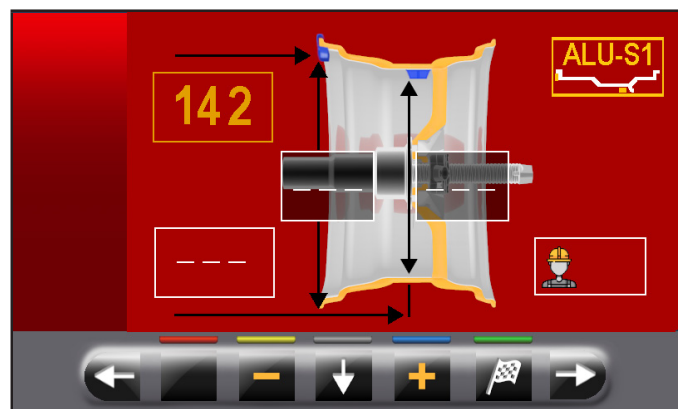

After entering all the required measures, you can spin

the wheel by pressing the button  and closing the protective guard.

In case the distance-diameter caliper was disabled, the displayed page for detected unbalance is as follows:

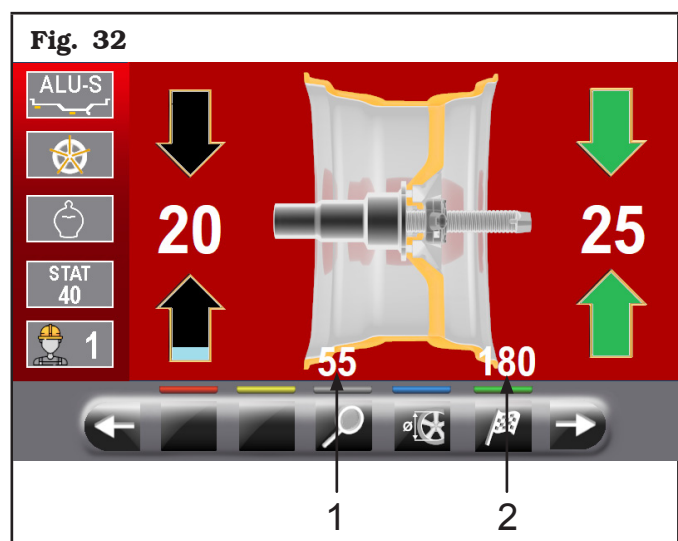

In this screen page, in addition to the information of the detected unbalance, there are measurements in mm where you must remove the gauge arm (**Fig. 32 ref. 1-2**) to apply the weights inside the rim.

13.7 Standard balancing programs

13.7.1 Static

The STATIC program permits balancing wheels by fitting adhesive weights on the outer and inner sides of the rim. Enter the measurements (see Par. 13.2.1 or 13.6.1) and proceed as described in Par. 13.5.

At the end of the procedure, the wheel balancing conditions can be checked by performing a trial spin.

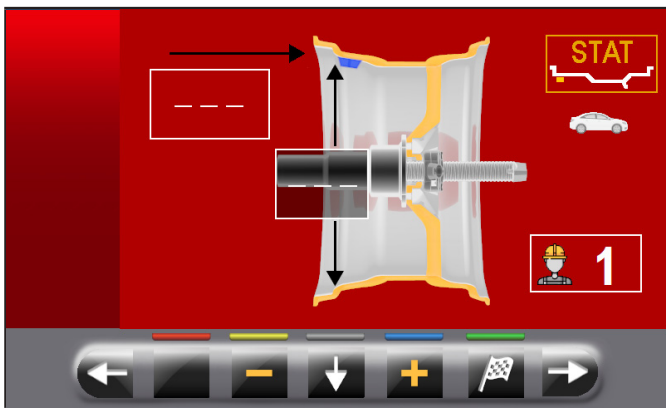

The procedure has now been completed.

13.7.2 Static-1

STATIC 1 function is a procedure that offsets wheel vibrations using a single weight with clip on a single plane positioned exactly at "12 o'clock".

Enter the measurements (see Par. 13.2.1 or 13.6.1) and proceed as described in Par. 13.5 "Dynamic balancing" (wheel inner side only).

At the end of the procedure, the wheel balancing conditions can be checked by performing a trial spin.

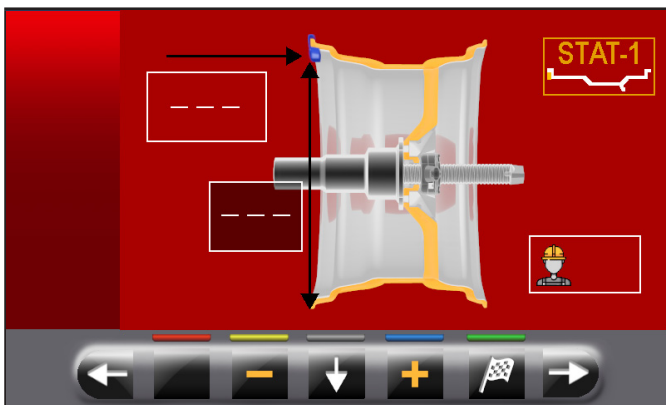

The procedure has now been completed.

13.7.3 Static-2

STATIC 2 function is a procedure that offsets wheel vibrations using a single adhesive weight on a single plane positioned exactly at "12 o'clock".

Enter the measurements (see Par. 13.2.1 or 13.6.1) and proceed as described in Par. 13.5.

At the end of the procedure, the wheel balancing conditions can be checked by performing a trial spin.

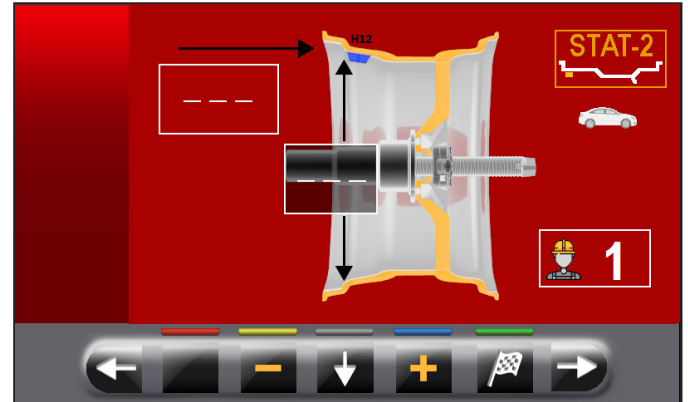

The procedure has now been completed.

13.7.4 Dynamic

The DYNAMIC program allows the wheels balancing by fitting two clip adhesive weights: one on the outside and one on the inside rim. Enter the measurements (see Par. 13.2.1 or 13.6.1) and proceed as described in Par. 13.5.

At the end of the procedure, the wheel balancing conditions can be checked by performing a trial spin.

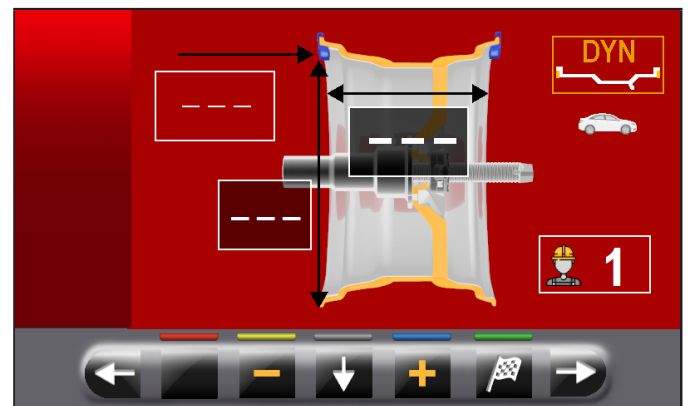

The procedure has now been completed.

13.7.5 ALU-S

ALU-S program permits balancing wheels by two fitting adhesive weights on the outer and inner sides of the rim. Enter the measurements (see Par. 13.2.1 or 13.6.1) and proceed as described in Par. 13.5.

At the end of the procedure, the wheel balancing conditions can be checked by performing a trial spin.

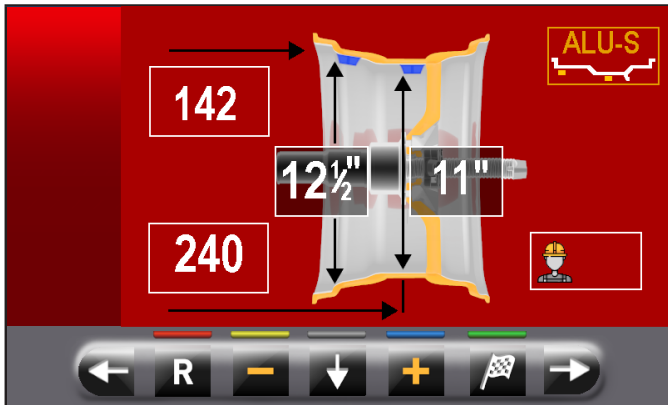

The procedure has now been completed.

13.7.6 ALU-S1

ALU-S1 function permits balancing wheels with light alloy rims by fitting adhesive weights on the outer side and weight with clip on inner side of wheel (at "12 o'clock").

Enter the measurements (see Par. 13.2.1 or 13.6.1) and proceed as described in Par. 13.5 (the inner weight is with clip).

At the end of the procedure, the wheel balancing conditions can be checked by performing a trial spin.

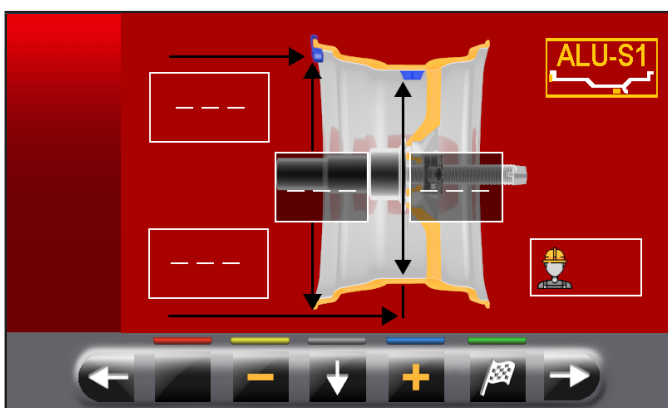

The procedure has now been completed.

13.7.7 ALU-S2

ALU-S2 function permits balancing wheels with light alloy rims by fitting two adhesive weights: one on the outer and one on inner sides of the rim (the inner weight is at "12 o'clock").

Enter the measurements (see Par. 13.2.1 or 13.6.1) and proceed as described in Par. 13.5.

At the end of the procedure, the wheel balancing conditions can be checked by performing a trial spin.

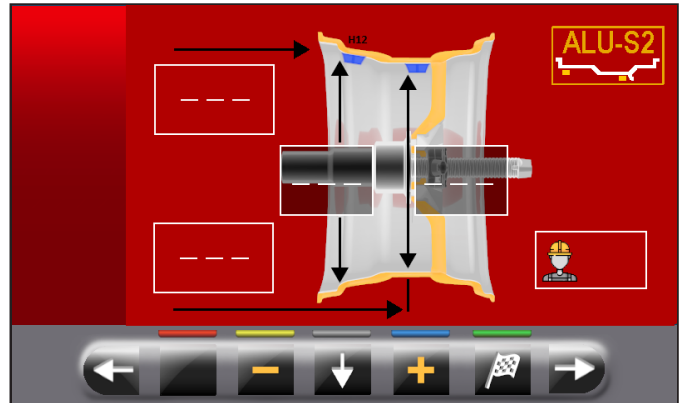

The procedure has now been completed.

13.7.8 ALU-1

ALU-1 function permits balancing wheels with light alloy rims by fitting adhesive weights on the outer and inner sides of the rim at "12 o'clock".

Enter the measurements (see Par. 13.2.1 or 13.6.1) and proceed as described in Par. 13.5.

At the end of the procedure, the wheel balancing conditions can be checked by performing a trial spin.

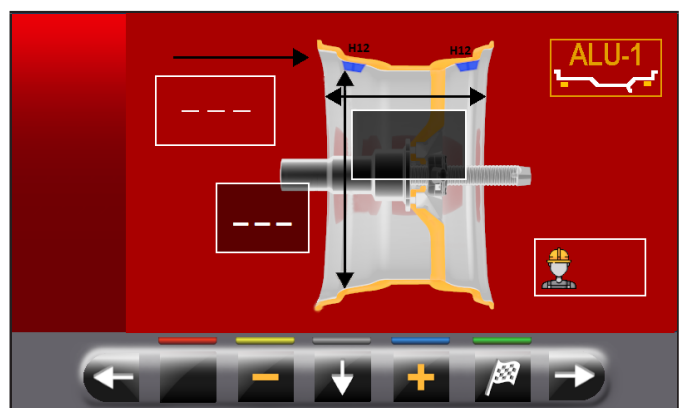

The procedure has now been completed.

13.7.9 ALU-2

ALU-2 function balances wheels with light alloy rims by fitting adhesive weights on the outside and inside of the rim. The position of the outer weight is not visible but hidden inside. Enter the measurements (see Par. 13.2.1 or 13.6.1).

At the end of the procedure, the wheel balancing conditions can be checked by performing a trial spin.

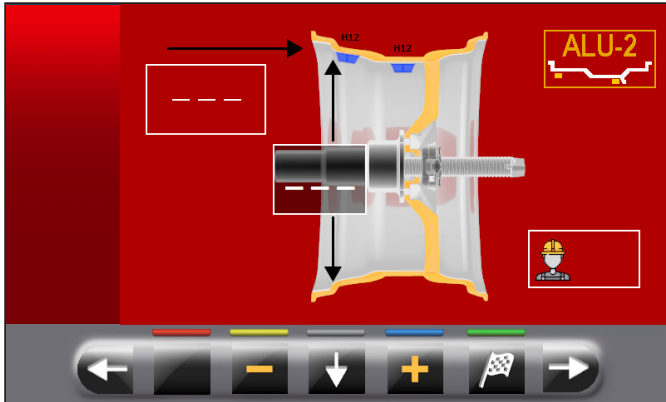

The procedure has now been completed.

13.7.10 ALU-3

ALU-3 function is a procedure that uses mixed weights to offset wheel unbalance: weight with clip on inner side of wheel, adhesive weight on outer side, not visible because inside the rim.

Enter the measurements (see Par. 13.2.1 or 13.6.1) and proceed as for a dynamic unbalance only for the inner side of the wheel.

At the end of the procedure, the wheel balancing conditions can be checked by performing a trial spin.

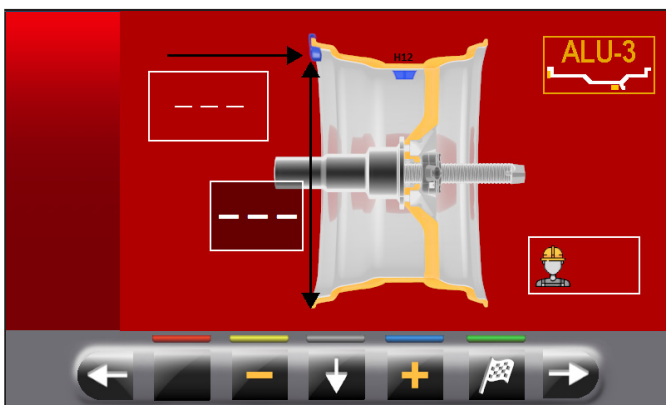

The procedure has now been completed.

13.7.11 ALU-4

ALU-4 function is a procedure that uses mixed weights to offset wheel unbalance: weight with clip on inner side of wheel, adhesive weight on outer side.

Enter the measurements (see Par. 13.2.1 or 13.6.1) and proceed as for a dynamic unbalance only for the inner side of the wheel.

At the end of the procedure, the wheel balancing conditions can be checked by performing a trial spin.

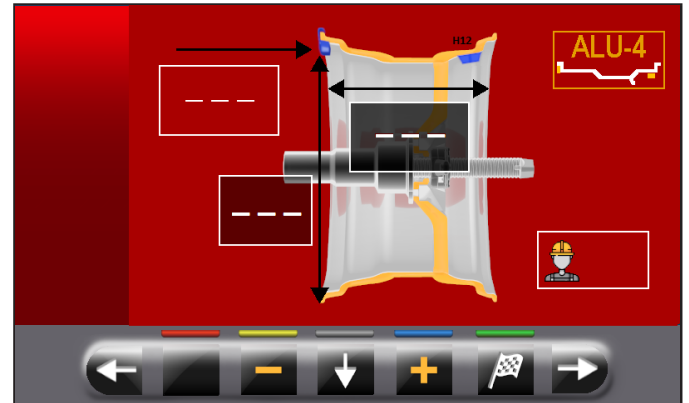

The procedure has now been completed.

13.8 Optional balancing programs

13.8.1 ECO-WEIGHT mode



TO USE THE ECO-WEIGHT PROCEDURE IT IS NECESSARY THAT THE DISTANCE-DIAMETER CALIPER ARM IS ENABLED IN THE "OPTIONS" MENU DESCRIBED IN PAR. 14.1.



THE ECO-WEIGHT PROCEDURE CAN ONLY BE USED WITH THE PROGRAM ALU-S.

This procedure represents a modern system for the reset of the unbalance in order to reduce weights consumption. This procedure ensures a fastest execution of the operations, thanks to a lesser number of spins and repositioning.

After making the wheel spin in ALU-S mode, the monitor shows the total of 2 adhesive weights to precisely correct STATIC and DYNAMIC unbalance.

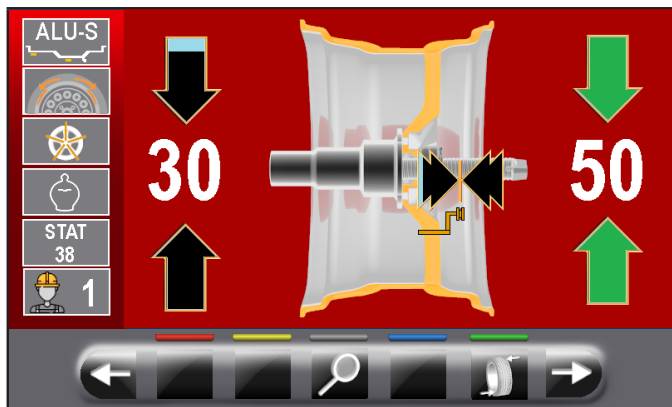

It is possible to fit a single weight at a predetermined distance from the machine, so as to optimize the weight consumption and reduce both the DYNAMIC and any remaining STATIC unbalance as much as possible.

Unlike the standard STATIC procedure, the ECO-WEIGHT procedure, though only using one weight, also considerably reduces the DYNAMIC unbalance, because the fitting distance of the weight on the rim is also calculated.

From ALU-S unbalance results page, if there is con-

siderable static unbalance, press the button  to display on the following monitor screen:

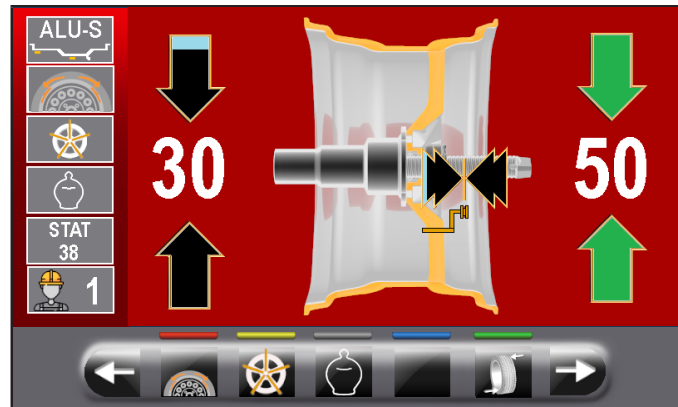

Press button  to select such procedure and bring automatically the wheel into weight fitting position.

Fig. 33



KEY

- 1 – Only weight to be fitted
- 2 – Last program and last values used for the spin
- 3 – Residual dynamic unbalance value (if the value is yellow, it is not recommended to carry out ECO-WEIGHT procedure)
- 4 – Static unbalance value (if the value is yellow, it is not recommended to carry out ECO-WEIGHT procedure)
- 5 – Residual dynamic unbalance value (if the value is yellow, it is not recommended to carry out ECO-WEIGHT procedure)
- 6 – Arrows indicating the weight fitting point with distance-diameter caliper arm

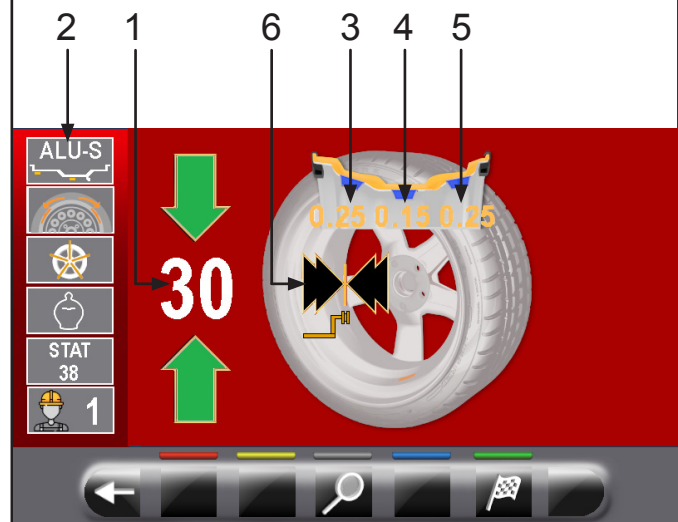
Press the brake pedal and fit the adhesive weight inside pliers as shown in **Fig. 34**.

Fig. 34

Fit the adhesive weight
in the pliers of the gauge rod



Pull out the gauge rod until the arrows (**Fig. 33 ref. 6**) turn green.

Fig. 35

Fit weight on the position
where pliers touches the wheel



At the end of the procedure, the wheel balancing conditions can be checked by performing a trial spin. The ECO-WEIGHT procedure has now been completed.



IMMEDIATELY AFTER HAVING SELECTED THE ECO-WEIGHT PROCEDURE, YOU CAN KNOW IN ADVANCE THE TWO DYNAMIC UNBALANCES AND THE STATIC RESIDUE IN ORDER TO DECIDE WHETHER IT IS CONVENIENT TO CONTINUE (SEE FIG. 33). IF BOTH DYNAMIC UNBALANCES AND STATIC RESIDUE ARE SHOWN AS WHITE VALUES ON THE MONITOR, THIS MEANS THAT THE PROGRAM HAS DECIDED THAT IT IS BETTER TO CONTINUE. WHILE IF, ON THE OTHER HAND, ONE OR MORE VALUES ARE YELLOW, THE PROGRAM SUGGESTS USING THE STANDARD ALU-S PROCEDURE.

13.8.2 SPLIT mode

Split procedure proves useful when the dynamic unbalance of a wheel is fairly high and the weight to be fitted is not available, for instance a 100 g weight. It's possible then to correct the unbalance dividing the amount of weight into two weights of smaller size.

Split procedure eliminates errors by using "DYNAMIC" program, for example by manually fitting two 50 g weights close to one another, instead of only a 100 gr one.

For example:

100 g WEIGHT TO BE FITTED TO
CORRECT UNBALANCE



TWO SMALLER WEIGHTS (50g)
FITTED MANUALLY



TWO SMALLER WEIGHTS (55g)
USING SPLIT PROCEDURE



Proceed to "DYNAMIC" unbalance measurement displaying by performing a standard wheel spin.

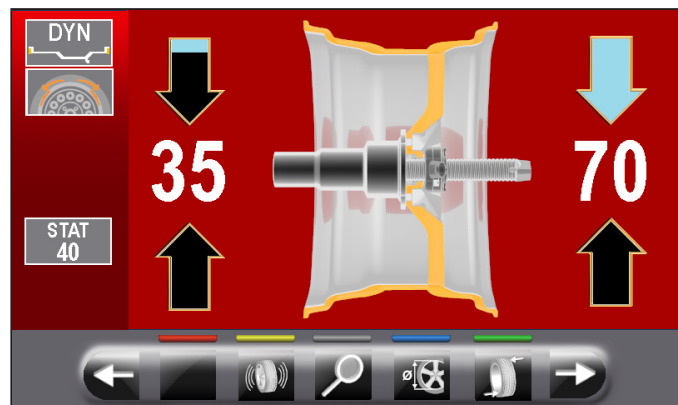

Once detected the unbalance values, verify that the machine displays the ability to use the "SPLIT" option

(Fig. 30 ref. 4a). Press button  to shift to the next screen page.



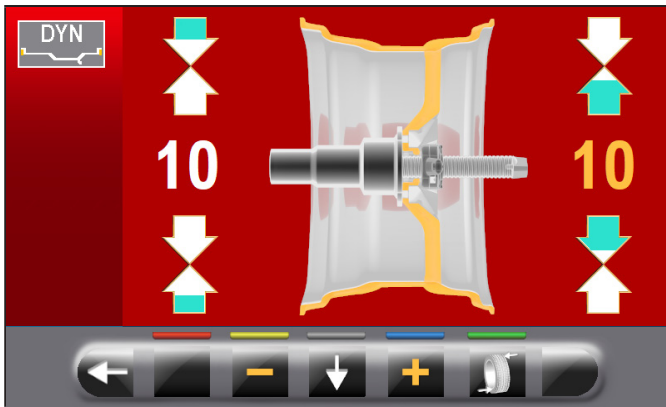

Press button  to enter "SPLIT" function. On the monitor screen will be displayed where you must enter the value of the weights to be fitted.

LIBRAK350



Press button  to select the outer weight to edit.

Press buttons  or  to increase or decrease the total weight to be fitted.



THE YELLOW VALUE INDICATES WHICH VALUE IS ACTIVE AND YOU ARE EDITING.



THE HIGHER THE CHOSEN WEIGHTS VALUE IS, THE MORE THEY WILL BE SPACED.

After choosing the value of the weights to be fitted,

press button  to position the wheel for the application of the 1st clip weight.

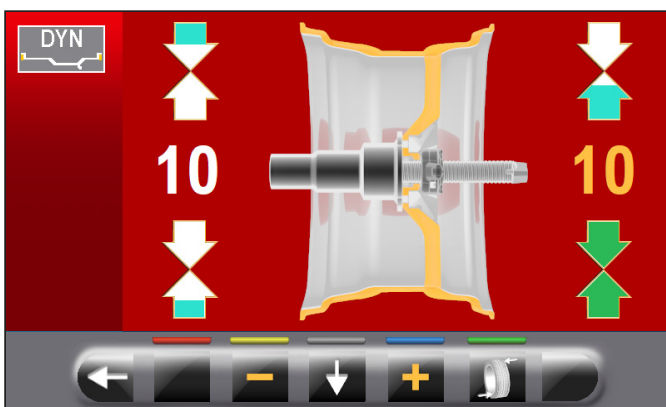

THE TWO GREEN ARROWS INDICATE THAT THE WHEEL IS PROPERLY POSITIONED FOR THE APPLICATION OF THE 1ST WEIGHT.

Fit the clip weight of the chosen value at "12 o'clock" on the outside of the wheel. Press again button  to position the wheel for the fitting of the 2nd clip weight.

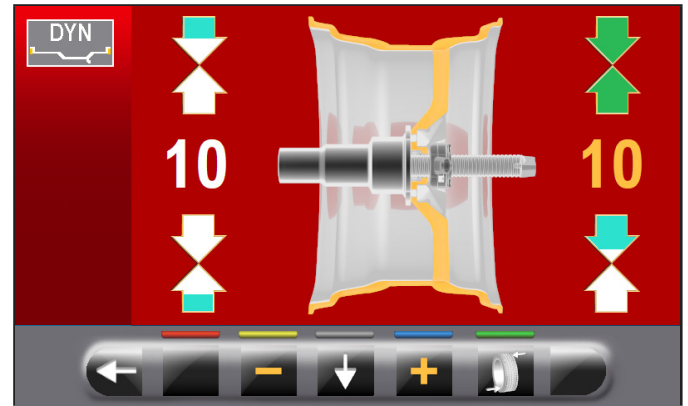

Fit the clip weight of the chosen value at "12 o'clock" on the outside of the wheel. Press button  to highlight the value of the weights to be fitted on the inside of the wheel.

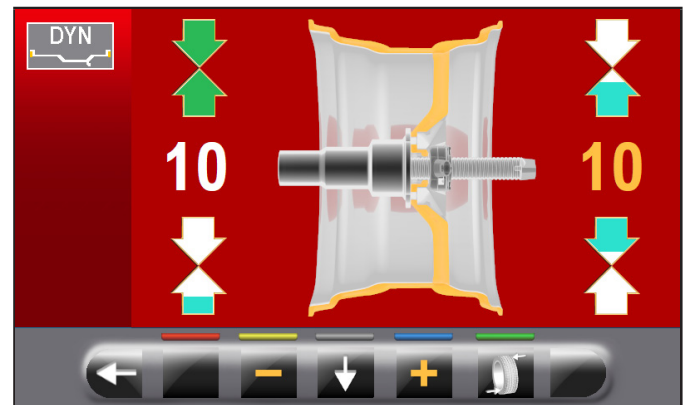

Repeat the above steps for the weights to be fitted inside the wheel.

At the end perform again a checking spin to see that you have applied the weights correctly.

13.8.3 Weights hidden behind spokes mode

Adhesive correction weight positioning may not look attractive on some types of rims. In this case, "weights hidden behind spokes" mode can be used: it splits any correction weight on the outer side into two parts to be hidden behind rim spokes. It can be used in ALU-S mode.

Proceed to ALU-S unbalance measurement displaying by performing a standard wheel spin.

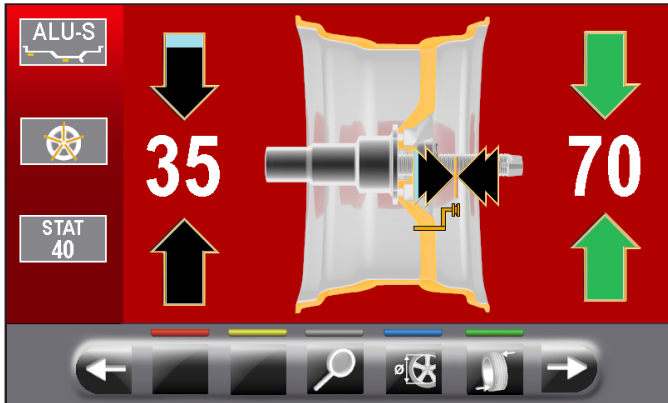

Once detected the unbalance values, verify that the machine displays the ability to use the "spokes" options (Fig. 30 ref. 4b). Press button  to shift to the next screen page.

Press button  to enter the relevant function. On the monitor the next screen page will be displayed:

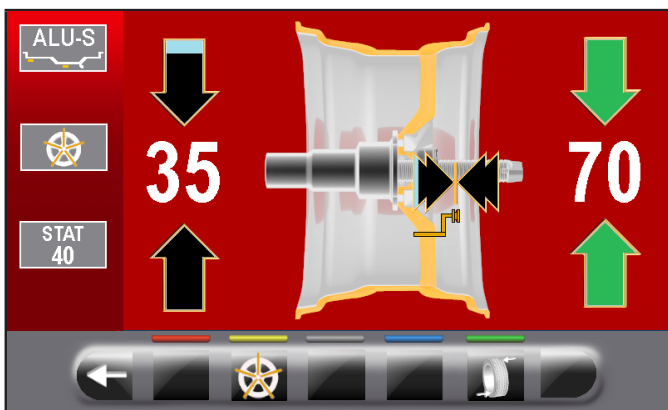

Press button  to enter the relevant function. On the monitor the next screen page will be displayed:

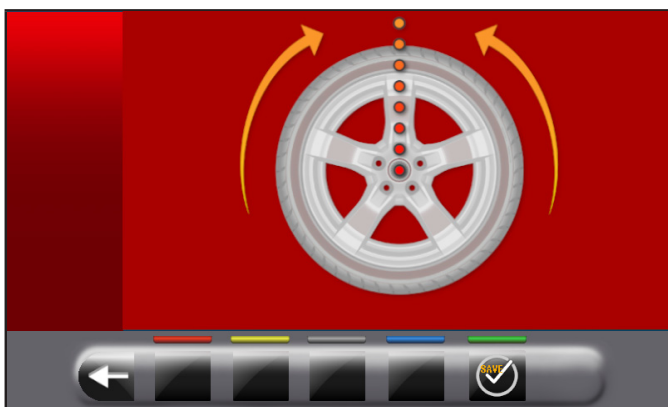

Bring any spoke upwards at "12 o'clock" position and

press the button  to confirm and continue.

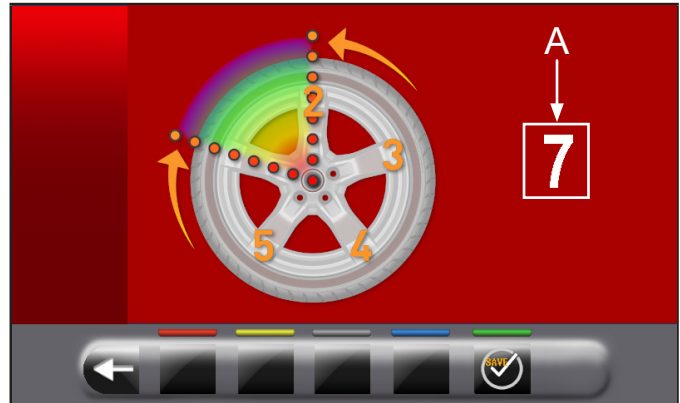

Lead to "12 hours" the 2nd spoke. The machine will automatically calculate the total number of spokes. If the value shown on the screen (A) is correct, press the

button .

The machine automatically calculates weight position in two positions hidden behind the spokes. The monitor shows the amount of weight to be applied behind the FIRST spoke and the rim will reach the position to apply the FIRST weight.

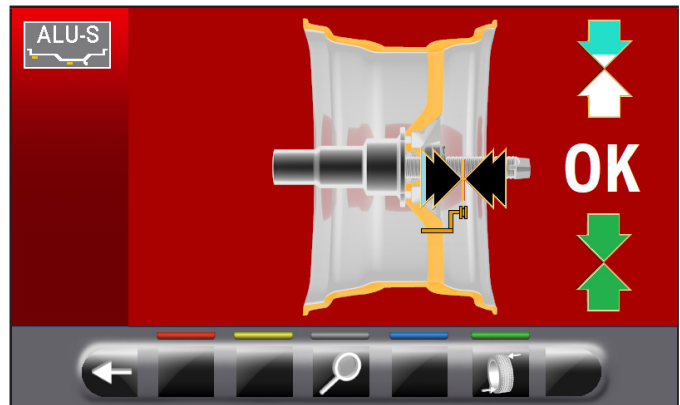

Extract the gauge rod, and fit the FIRST weight in the position shown by the machine, as explained in

Par. 13.5.1. Press the button  to confirm that they have applied the FIRST weight and to automatically position the wheel for the fitting of the 2nd weight. The monitor shows the amount of weight to be applied behind the SECOND spoke.

Pull out the gauge rod and fit the SECOND weight in the position shown by the machine, as done for the first weight.

Press the button  to confirm that you have applied the SECOND weight and get back to the initial situation of unbalance, before performing the "weights hidden behind the spokes" procedure.

Perform another test spin.

The “weights hidden behind spokes” procedure is completed.

Complete the operation by adding an additional weight inside the rim as required by the selected mode (ALU-S).

13.8.4 Matching mode

The Matching procedure offsets strong unbalance, reducing the weight quantity to be fitted on the wheel to achieve balancing. This procedure permits reducing unbalance as much as possible by offsetting the tyre unbalance with that of the rim in any used program. Proceed to unbalance measurement displaying by performing a standard wheel spin.



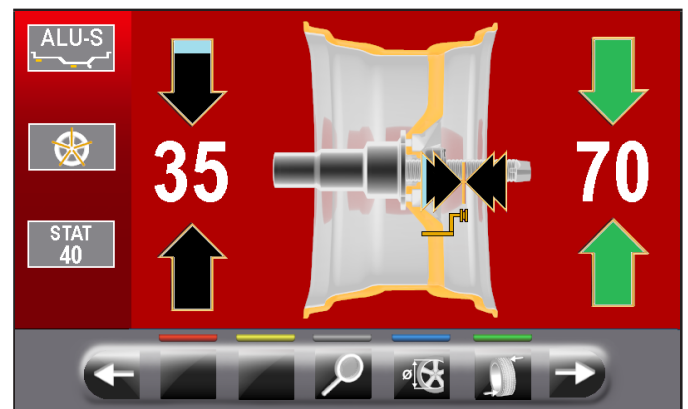

THE MATCHING PROCEDURE CAN BE CARRIED OUT ONLY IF THE STATIC UNBALANCE IS > 30 G.

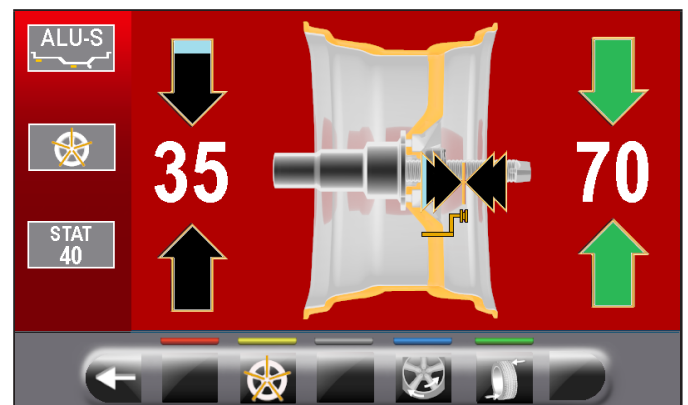

Once detected the unbalance values, verify that the machine displays the ability to use the “matching” options (**Fig. 30 ref. 4a**).

Press button  to shift to the next screen page.



Press button  to enter the relevant function.

On the monitor the next screen page will be displayed:



STEP 1. Move the slider on the flange to the "12 o'clock" position. Make a reference mark, using chalk for instance, on the rim and tyre, in line with the arrow on the flange, so as to be able to fit the rim back on in the same position on the machine.

Make a reference mark on the rim and tyre, in line with the arrow on the flange

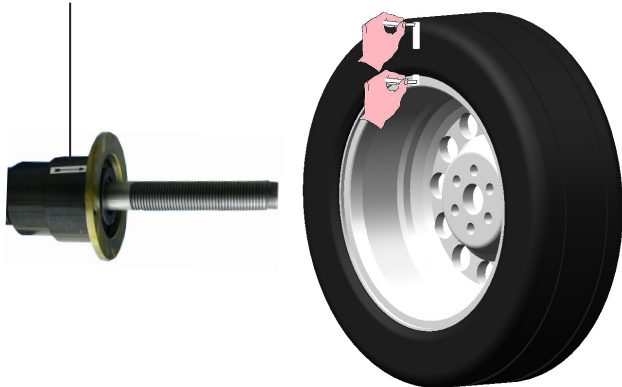

Press button  to confirm that step 1 has been completed.

On the display the next screen page will be displayed:

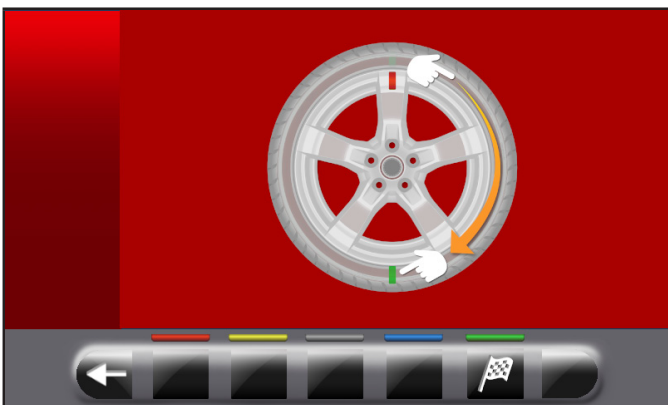

STEP 2. Remove the wheel from the wheel balancer. Remove the tyre and turn it on the rim through 180°.

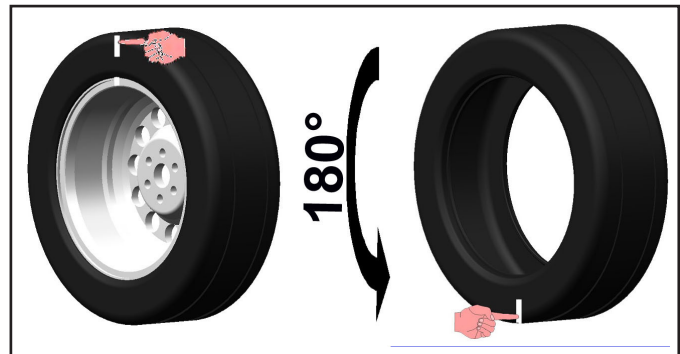

Fit the wheel back on the wheel balancer, positioning the reference mark on the rim in line with the arrow on the flange.

Position the reference mark on the rim in line with the arrow on the flange

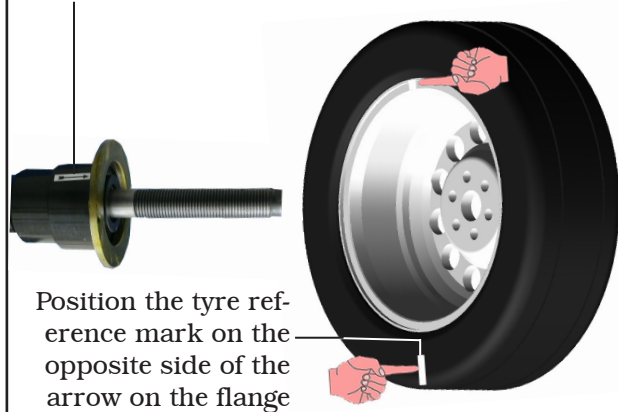

Position the tyre reference mark on the opposite side of the arrow on the flange



Press button  to confirm that step 2 has been completed.

On the display the next screen page will be displayed suggesting to perform a spin of the wheel.

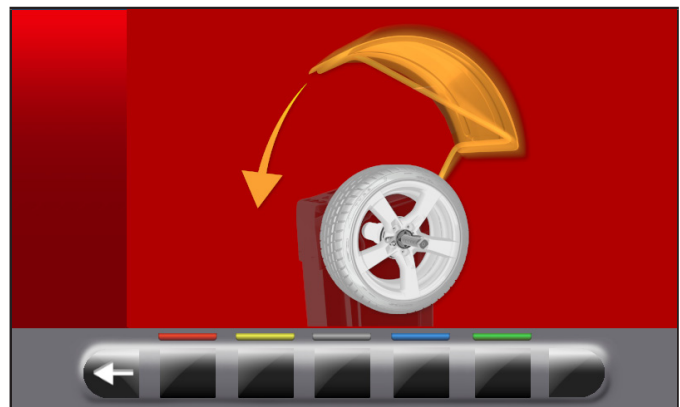

After having fitted wheel back in position, close the protection guard to make an automatic wheel spin. At the end of the spin the monitor will display the screen illustrated afterwards.

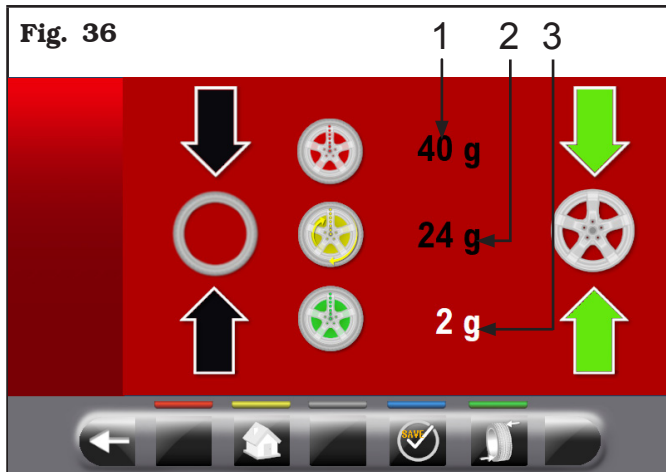

In this screen you will see the dynamic unbalance that the wheel had before performing the operation (**Fig. 36 ref. 1**), the dynamic unbalance after having rotated the tyre through 180° compared to the rim (**Fig. 36 ref. 2**) and the unbalance which can be obtained following the directions of the machine (**Fig. 36 ref. 3**).

STEP 3. If the value of possible unbalance reduction is high, you can proceed as follows:

- Cancel the previously made reference marks. Put new signs, as described below.



- Press the button  to bring the wheel into position.



Make the reference mark on RIM at "12 o'clock" (see **Fig. 37**).

reference mark on RIM

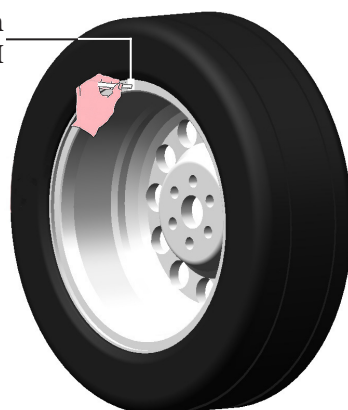
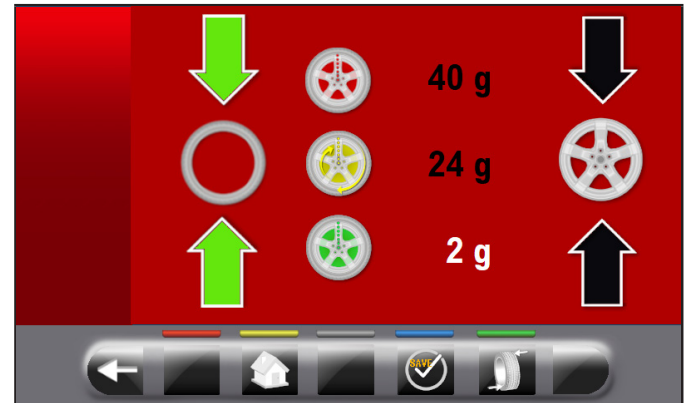

Fig. 37

- Press the button  to bring the wheel into position.



Mark the reference mark on the TYRE at "12 o'clock" position.



Press button  to confirm that step 3 has been completed.

STEP 4. Remove the wheel from the wheel balancer. Demount and mount the tyre again on the rim so as to bring the two reference marks (rim and tyre) to coincide. Refit the wheel on the balancer (see **Fig. 38**) with the two reference marks next to the arrow on the flange.

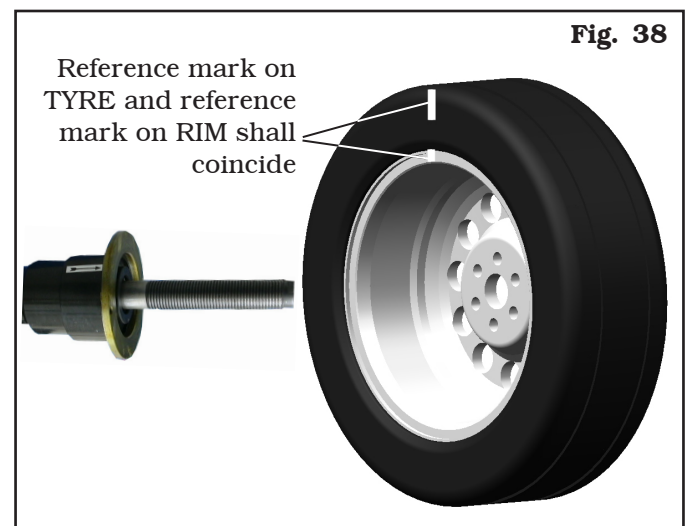

Press button  to confirm that step 4 has been completed.

Perform another spin closing the protection guard, to check the expected unbalance reduction and correct any residual unbalance, as described in Chap. 13.5.1.

13.9 Special balancing programs

13.9.1 Pax

PAX mode is a special procedure specially devised to balance wheels using the "PAX System ®". 2 adhesive weights on different planes are used on rim inner side.

To launch a PAX measurement, proceed as follows:

- Make sure there are no stones and/or mud on the wheel. Remove any counterweights. Fit the wheel and make sure it is properly fastened (see Chap. 11).

- Press  button from "Home" page. On the screen

that appears, press the button  to switch to measuring mode selection screen below.



Use the arrows  or  to select PAX mode.

At the end press push button . The machine will be configured as follows to perform the measurement and on the video screen will appear the indication of the specific measures of the selected wheel type.

- Close the protection guard to perform the automatic wheel spin.

In just a few seconds, the wheel runs at normal speed and the monitor shows wheel rotation.

After the spin, the wheel stops automatically, taking into account the measured unbalance so that the fitting position of the weight will be at "12 o'clock".

The monitor show the weight required to correct the unbalance.

Open the protection guard and proceed to fit the adhesive weight as shown for the ALU-S mode (see Par. 13.7.5).

13.10 Recalculation function

After making a spin, the wheel automatically stops, indicating the weight/s to be fitted and its/their position. In case the operator does not want the type of wheel balance proposed by the machine (program type, weights size, etc ...), proceed with the re-calculation of the wheel balancing without rerunning the spin of the wheel.

To do this, proceed as described below:

- press the button  to return to the measures detection/program selection page;
- select a new balancing program as indicated in Par. 13.2.2;
- take with the gauge arm the measures required by the selected program;

- press button  to perform the re-calculation. The monitor will display the weights and the positions in which they will be applied.

If also in this case the operator should decide to further modify the balancing program, it is sufficient to proceed as described above without having to spin the wheel.

When the result of the recalculation does not satisfy the operator, it is recommended to do a spin of the wheel to confirm the findings from the operation of recalculation itself.

After the launch of the wheel, the machine, in addition to displaying the unbalance value, draw up automatically all the programs measurement fields that are consistent with those measures that were taken previously and at the same time erases all measures which are not consistent.

13.11 Wheel balancing in Motorcycle mode (with distance caliper extension Kit)

By enabling "motorcycle wheel balancing" function, the wheel balancers can also balance motorcycle wheels. Before detecting the wheel sizes (see Par. 13.2.2), select motorcycle wheel balancing mode proceeding as described below:

press the button  then the button  and,

finally, press the button  to go to measurement acquisition program selection screen page.

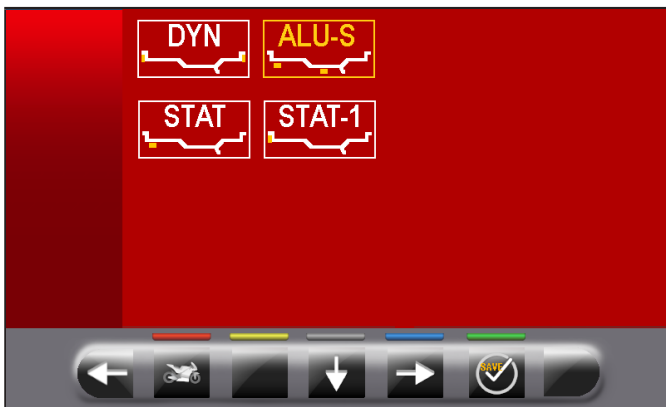

Use arrows  and/or  to select the mode desired.

At the end press push button .

The machine will be configured as follows to perform the measurement in the desired mode and on the screen will appear an indication showing the measures that will be acquired.

The "motorcycle" mode automatically recalculates the wheel distance measurement, increasing it by the length of the extension supplied with distance caliper extension kit (kit available on demand).



THE EXTENSION MUST BE FITTED ONLY WHEN BALANCING IS PERFORMED IN "MOTORCYCLE" MODE.



TO MOUNT THE EXTENSION AND THE COMPONENTS OF CALIPER EXTENSION KIT, PLEASE REFER TO THE SPECIFIC INSTRUCTIONS INCLUDED IN THE KIT.

Balancing procedures are identical for both modes (car/motorcycle).

By selecting motorcycle mode, besides DYNAMIC balancing (see Par. 13.7.4) STATIC balancing and/or ALU-S (Par. 13.7.1 and/or 13.7.5) can also be performed.

14.0 USER MENU (OPTIONS AND CALIBRATION)

From the main page "Home" press the button 

to move to the next screen page and the button  to access the user menu. On the monitor, the following screen appears where you can enter the password.

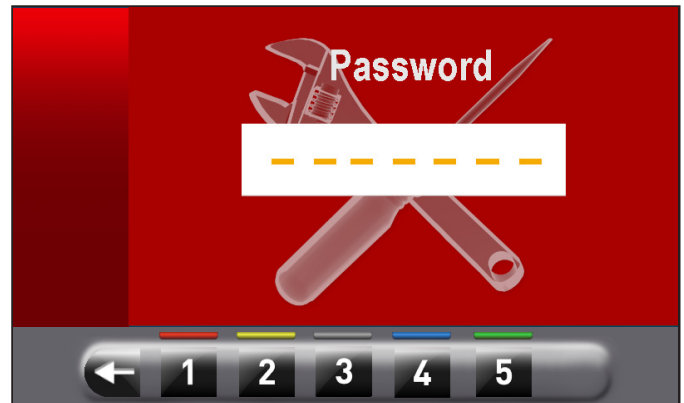

The user login password is: **1234**.

After entering the correct password you will see the following screen:

Fig. 39

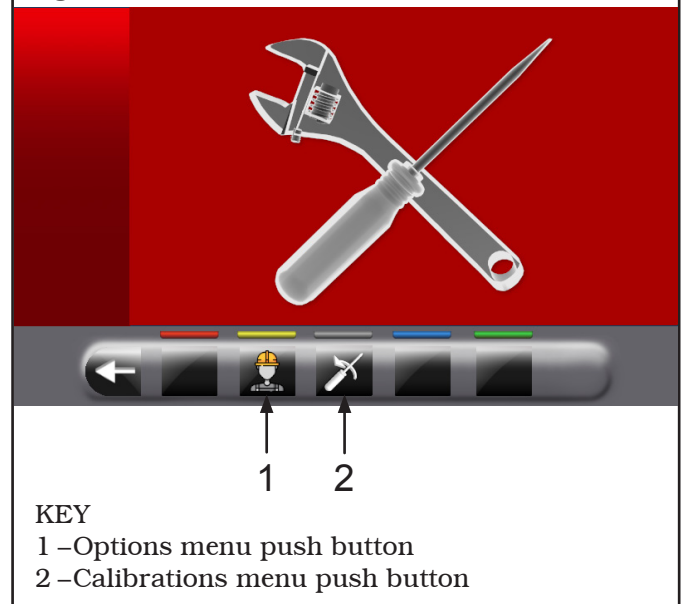

KEY

1 - Options menu push button

2 - Calibrations menu push button

14.1 Options menu





Press button  to display the monitor screen to enable/disable the options as shown below:



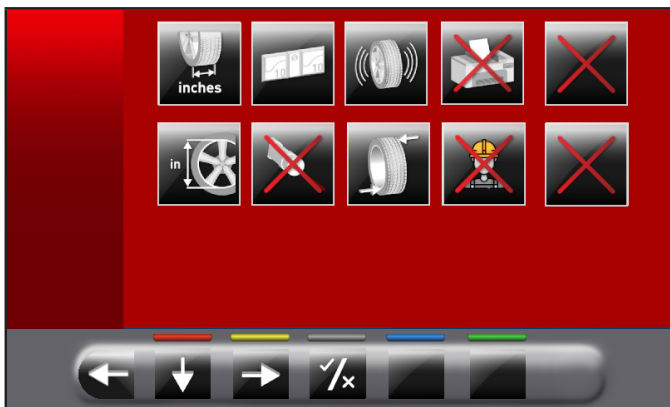

Press button  several times to display the second option screen page reported as follows.



To enable / disable individual functions simply high-

light the icon using the buttons  and/or 

and press the button .

Pressing the button  may involve, besides, the change in the unit of measure from "mm" to "inch" and vice versa (where applicable) or access to a sub-screen for values settings values (see Par. 14.1.1 or 14.1.2). After you select/deselect the desired options, exit the

menu by pressing push button .

List of available options



THE ICONS OF THE AVAILABLE OPTIONS WILL TURN BLUE WHEN THEY ARE SELECTED.



OPTIONS THAT ARE NOT AVAILABLE ARE MARKED WITH A RED "X".



Enables/disables the spin/protection carter.



Enables/disables the distance/diameter detection caliper.



Enable/disable the display of static threshold after each spin.



It allows you to set the thresholds for each of the balancing mode weights (see Par. 14.1.1).



Enable/disable the pneumatic brake after the spin.



When activated, gram weight display unit is set.



When activated, ounce weight display unit is set. When this option is enabled, weight display unit can be modified from ounces to grams and vice versa.



It allows to enable/disable the width function detected by external data gauge.



Enable/disable ECO-WEIGHT function.



Enable/disable the positioning of adhesive weights at "6 o'clock".



Enable/disable the lock function for caliper arm in position.

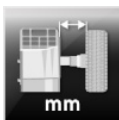

It allows you to change the unit of measure of the distance of the weights fitting point from mm to inches and vice versa.

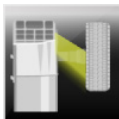

Enable/disable the LED-light.



Enable/disable the dynamic residues in the ECO-WEIGHT function.



Enable/disable the functions of motorcycle wheel balancing.



Enable/disable the encoder mounted on the spin motor.



It allows you to change the unit of measurement of the rims width from mm to inches and vice versa.



It allows you to set the size values of adhesive weights (see Par. 14.1.2).



Enable/disable the RUN-OUT functions.



Enable/disable the functions of machine printing.



It allows you to change the unit of measurement of the rim diameter from mm to inches and vice versa.



Enable/disable the weights positioning laser function.



Enable/disable the repositioning of the wheel at the end of the spin.



Enable/disable user function.



It allows the setting of the retrieval of the measures by eye: readout of measures printed on the rim and the graduated scale of the distance-diameter caliper.

NOTE: it is activated only if distance-diameter caliper is disabled.



Enable/disable the use of the manual caliper to measure rim width.

NOTE: it is activated only if distance-diameter caliper is disabled.



Enable/disable the function of clip weights positioning laser wheel inner/outer side "at 12 hours".

14.1.1 Lower weight limit

Correction weight below a certain limit is normally shown equal to zero. This limit can be set from 10 g to 1 g (from 0.5 oz to 0.05 oz).

At the end of the spin however, by pressing the button



the weight can be displayed with maximum resolution of 1 g (0.05 oz), not considering the set lower limit.



LOWER LIMIT FACTORY SETTING FOR DYNAMIC WHEEL BALANCING MODE IS 5 g (0.25 oz). THE LOWER LIMIT FOR ALL THE OTHER MODES IS SET AT 7 g (0.35 oz).

	Default values	Work range		
		g	oz	g
1 → OK	5	0.25	2 ÷ 50	0.05 ÷ 2.00
2 → OK	7	0.35	2 ÷ 50	0.05 ÷ 2.00
3 →	5	0.25	2 ÷ 50	0.05 ÷ 2.00
4 →	100	100	0 - 50 - 100 150 - 200	0 - 50 - 100 150 - 200

KEY

- 1 - Lower weight limit in the DYNAMIC program to display "OK" (default value 5 g (0.25 oz))
- 2 - Lower weight limit in the ALU-STATIC program to display "OK" (default value 7 g (0.35 oz))
- 2 - Weights display resolution (default value 5 g (0.25 oz))
- 4 - Weight % reduction in ECO-WEIGHT function (0 ÷ 200) (default value 100)

14.1.2 Setting adhesive weight dimensions and static threshold percentage

To ensure the balancing machine precisely calculates the dimensions and total adhesive weights, set the height (thickness) and width of the adhesive weights at your disposal (see Fig. 40).

Fig. 40

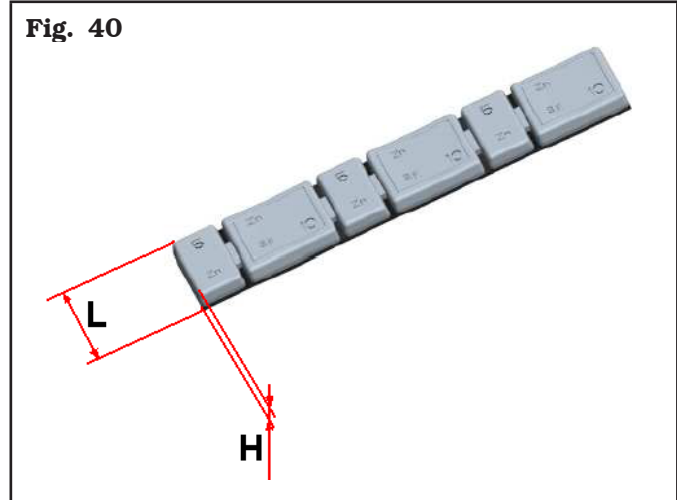

To carry out this setting, press the icon . You will see the following screen:



KEY

- 1 - Weights thickness (height) (default value 4 mm)
- 2 - Weights width (default value 19 mm)

From this screen page, change the size values of weights

using the buttons and .





THE YELLOW-COLOURED-VALUE IS THE ACTIVE FIELD AND THE MODIFIABLE ONE.

14.1.3 User management

The "User Management" function is disabled on machine delivery. To enable it, proceed as described in Para 14.1. After enabling, the icon will be displayed on every page (Fig. 41 ref. 1).

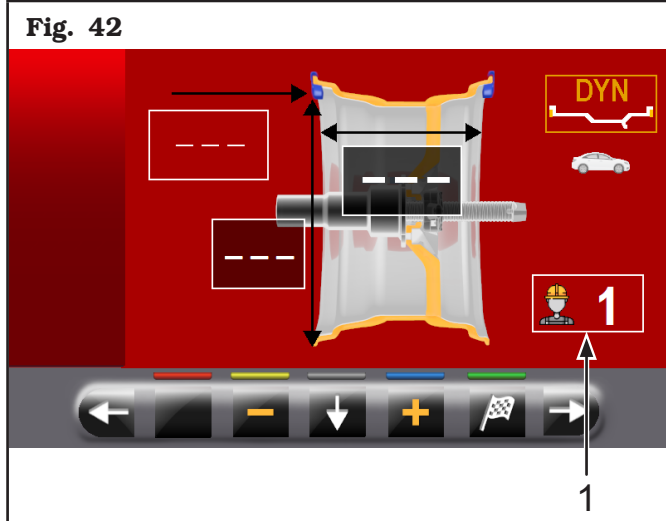
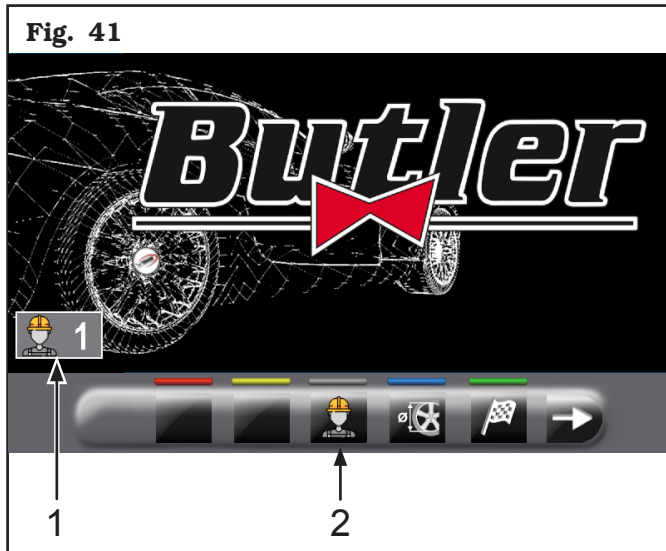
The wheel balancers can be used simultaneously by 4 different users.



Press button  shown on the monitor (Fig. 41 ref. 2) or select the field (Fig. 42 ref. 1) and subse-

quently press the button  to display the screen page below:

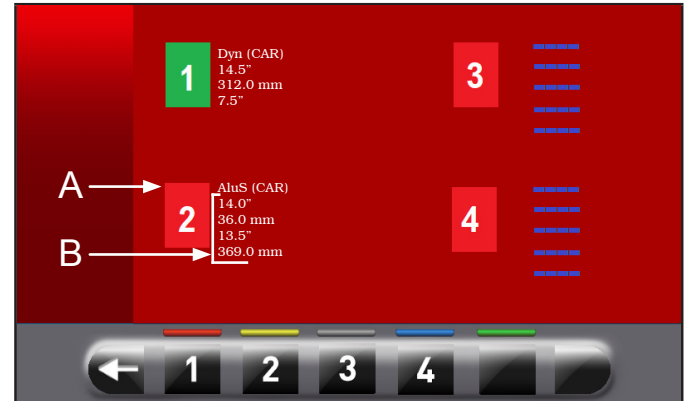

KEY

- A - Program used in the last carried out spin
- B - Acquired measurements for the last carried out spin

Press any of the available numbers on the buttons at the bottom of the page to select the corresponding user. The system stores the data relating to the last performed spin according to the different operators. You can recall the desired user each time the program displays the specific button (Fig. 41 ref. 2 and Fig. 42 ref. 1). The measurements stored for each user are lost when the machine is switched off. User management is valid for any wheel balancer function.



TO ENABLE OR DISABLE "USER MANAGEMENT" FUNCTION, SEE PARAGRAPH 14.1. IF THE FUNCTION IS DEACTIVATED, BUTTON  IS DISPLAYED.

14.2 Enabling of electronic Run-out measuring device (optional)

From the main page "Home" press the button 

to move to the next screen page and the button  to access the user menu. On the monitor, the following screen appears where you can enter the password.

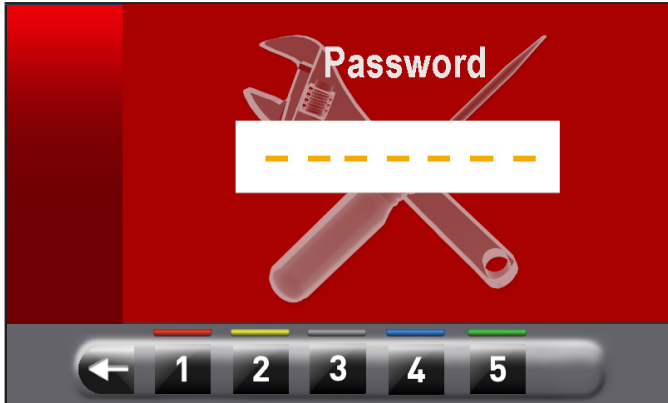

The user login password is: **1234**.

After entering the correct password you will see the following screen:

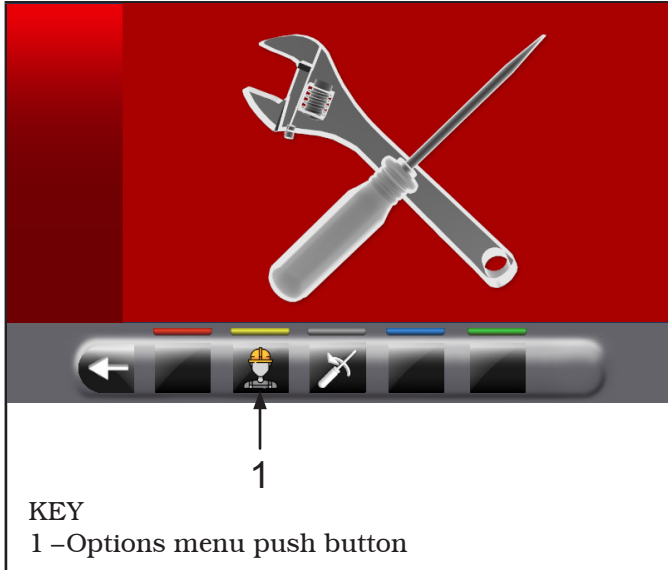

Press button  to display the monitor screen to enable/disable the options as shown below:



Press button  several times to display the second option screen page reported as follows.

Fig. 43

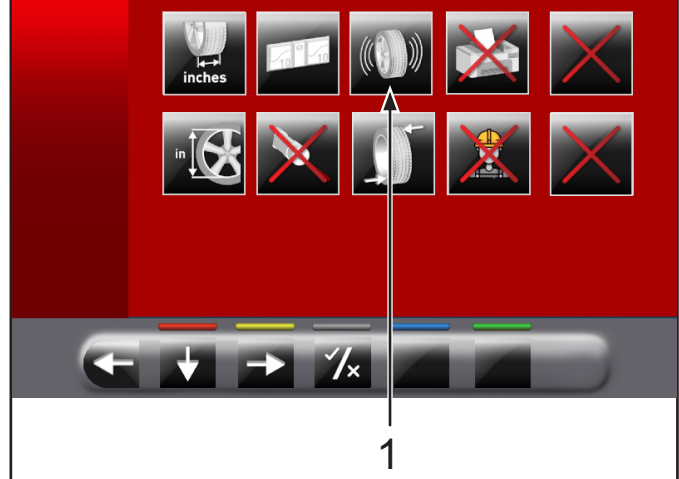

To enable / disable individual functions simply high-

light the icon using the buttons  and/or 

and press the button .

Remove symbol "X" on the icon (**Fig. 43 ref. 1**).

After you select/deselect the desired options, exit the

menu by pressing push button .

14.3 Machine calibrations



Press the button (Fig. 39 ref. 2) to display the following screen page on monitor:

Fig. 44

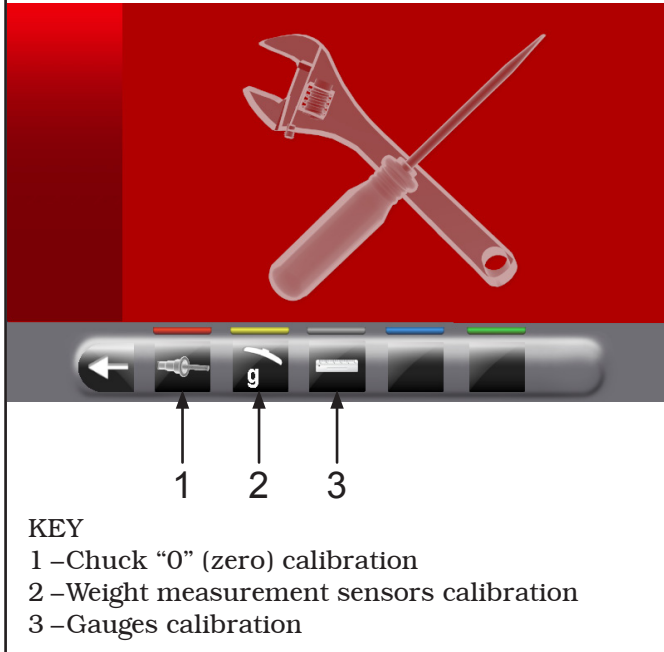

14.3.1 Chuck "0" (zero) calibration



Press the button (Fig. 44 ref. 1) to display the following screen page on the monitor:

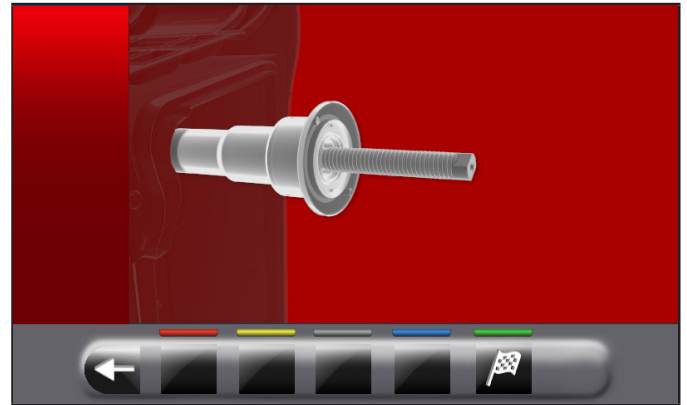

After making sure that the spindle is unloaded (no wheel or mounted accessories), press the button



and close the guard. The chuck will rotate for a few minutes until you see the screen below:



At this point the machine has all its measuring fields.



Press button to return to calibrations screen page.

14.3.2 Weight measurement sensors calibration



THE NUMERICAL VALUES SHOWN IN THE FIGURES BELOW ARE PURELY ILLUSTRATIVE.



ASSEMBLE A BALANCED WHEEL ON THE SPINDLE AND PERFORM THE SPINDLE "0" (ZERO) CALIBRATION PROCEDURE DESCRIBED IN PAR. 14.3.1 (WITH WHEEL MOUNTED).



- Press the button  (Fig. 44 ref. 2) to display the following screen page on the monitor:

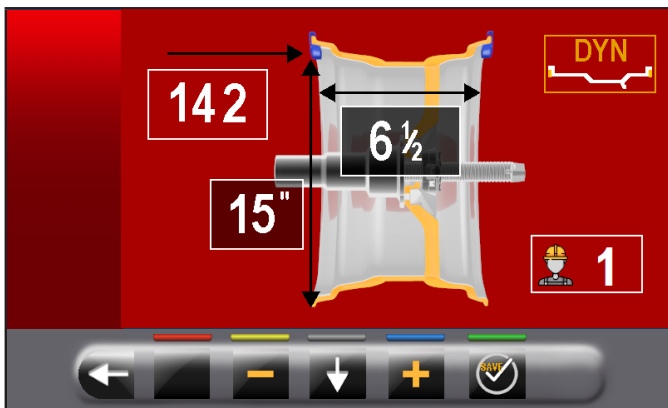

- Set the size of the rim on the chuck using the distance-diameter caliper arm.
- Set the rim width using one of the following calipers:
 - Manual caliper
 - External data gauge (optional)



- Press button  and close the guard to perform the 1st spin of the wheel without weights.
- At the end, on the monitor will appear the following screen, saying that you should apply a weight of 100 g to the "12 o'clock" outer rim.

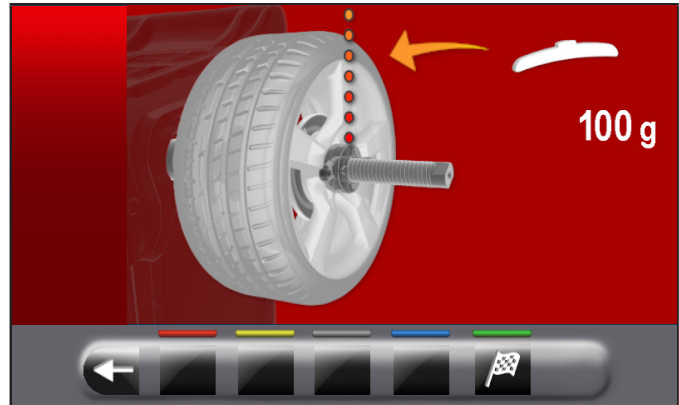

APPLY THE WEIGHT AT A POINT IN WHICH BOTH SIDES OF THE RIM THERE IS THE POSSIBILITY OF APPLYING A CLIP WEIGHT OF 100 g.

- Apply the weight and position it perfectly to the "12 o'clock".



- Press the button  and close the guard to perform the 2nd spin of the wheel (100 g weight placed on the outside of the wheel).
- At the end the following screen will appear on the monitor, suggesting to remove the weight of 100 g previously applied on the outer side and apply it on the inside of the rim.

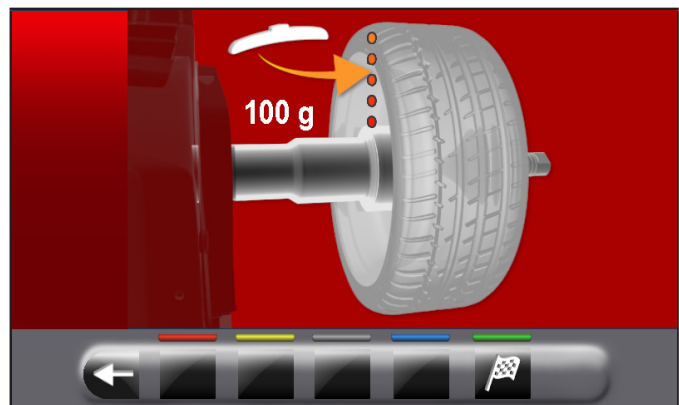

- Turn manually the wheel until You have the weight of 100 g on the outer side at "12 o'clock".
- Press the brake pedal and hold it down during the whole the following operation to avoid unexpected rotation of the spindle.

LIBRAK350

- Remove the weight from 100 g from the outside of the wheel and apply it on the inner side at "12 o'clock".



AT THIS POINT TAKE THE WEIGHT POSITIONED ON THE EXTERNAL SIDE AND PLACE IT EXACTLY IN THE SAME POSITION BUT ON THE INTERNAL SIDE, HELPING BY DRAWING A LINE ON THE TYRE AS A REFERENCE (SEE FIGURE BELOW).

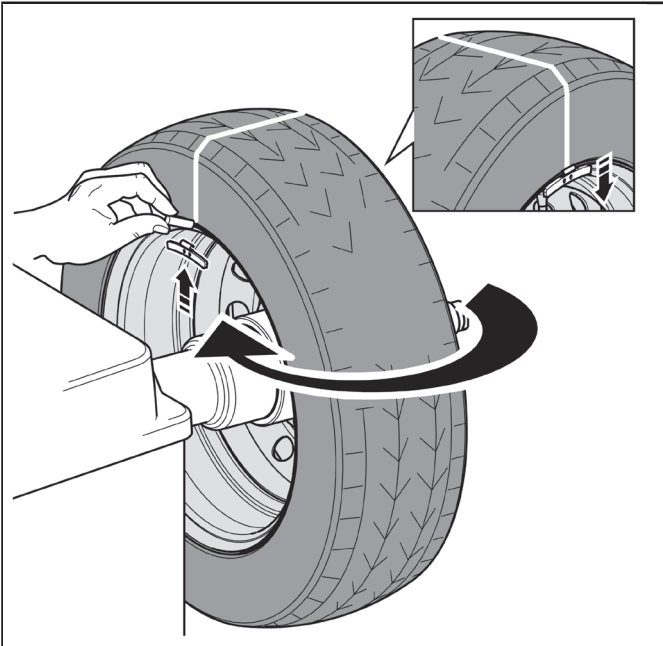

- Close the guard to perform the 3rd spin of the wheel (100 g weight placed on the inside wheel).

At the end of the rotation, the video screen below will be displayed to indicate that the operation is finished.

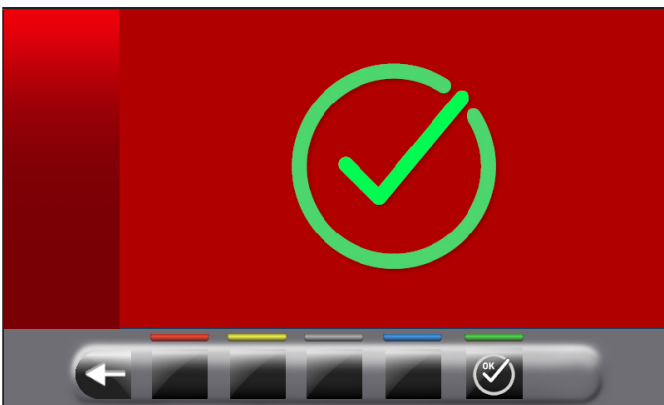

WHEN THE OPERATION IS CONCLUDED, REMOVE THE WHEEL FROM THE CHUCK AND PERFORM A COMPLETE CALIBRATION PROCEDURE "0" (ZERO) CHUCK AS DESCRIBED IN PAR. 14.3.1.

14.3.3 Gauges calibration

Press the button  (Fig. 44 ref. 3) to display the following screen page on the monitor:

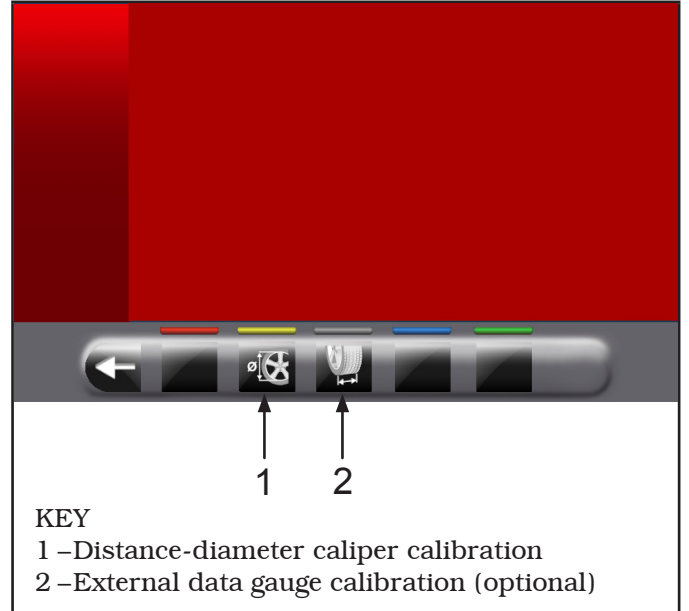

Distance-diameter caliper calibration



THE NUMERICAL VALUES SHOWN IN THE FIGURES BELOW ARE PURELY ILLUSTRATIVE.

Press the button  to display the following screen page on the monitor:

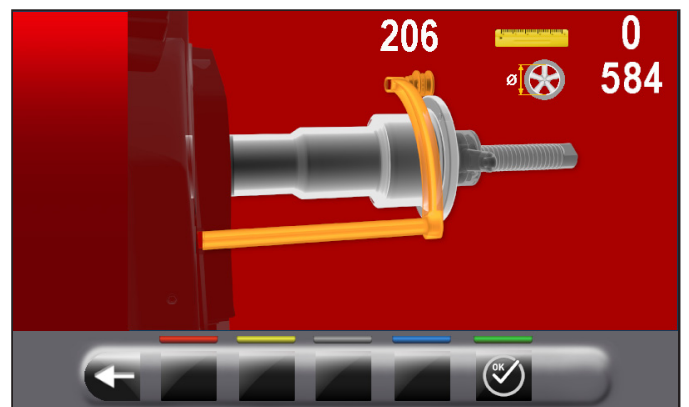

Place the gauge (**Fig. 45 ref. 1**) on the chuck flange (**Fig. 45 ref. 2**).

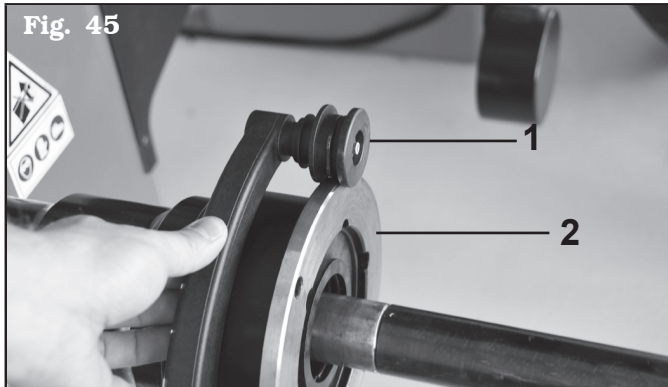

The following screen will appear on the monitor to indicate the measured values:

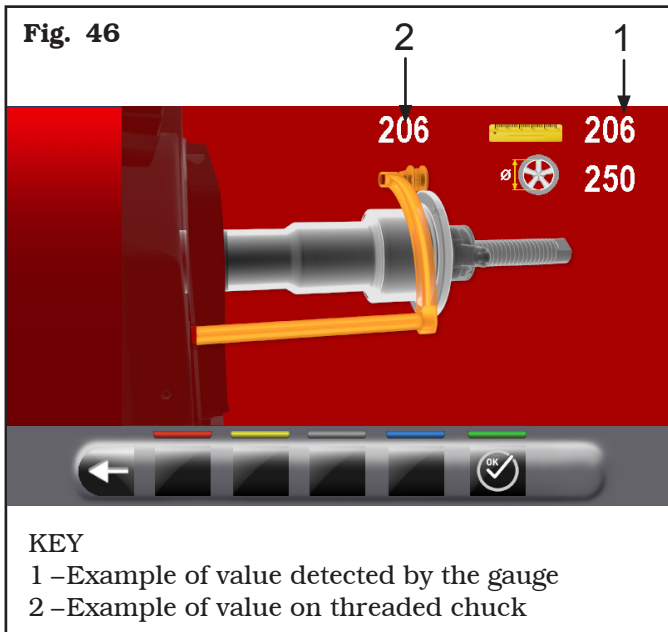

- The value next to the symbol "scale" (Fig. 46 ref. 1) must be equal to or ± 1 mm with respect to what is indicated above the caliper (Fig. 46 ref. 2).



- Press push button . The following screen will appear on the monitor:

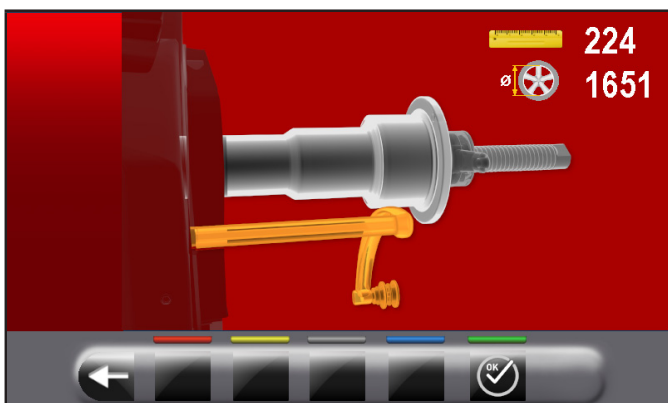

- Place the gauge as shown in the following figure:



- Press push button . Wait a few seconds until you see the following screen:

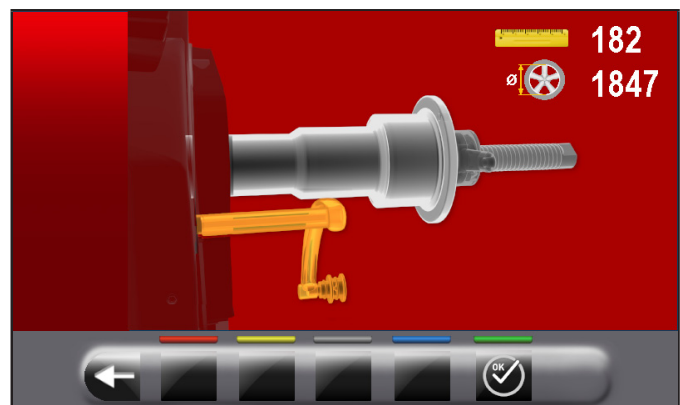

- Place the gauge against the chuck in the lower part of it but on a smaller diameter than before as indicated on the image on the monitor.



- Press push button . On the monitor the next screen page will be displayed:

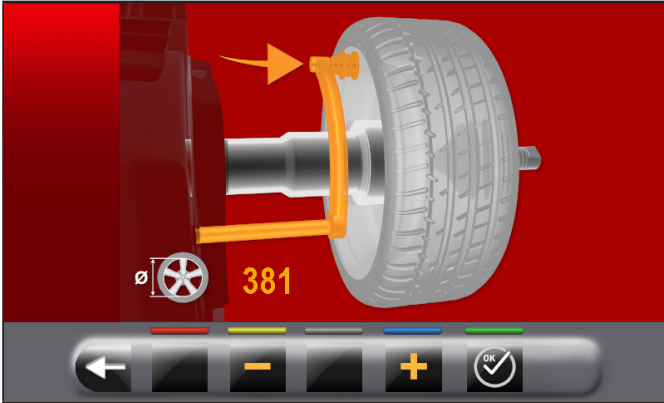

Measure the exact diameter of a rim (see **Fig. 47**) and place it on the screen on the monitor by pressing the

 or  buttons.

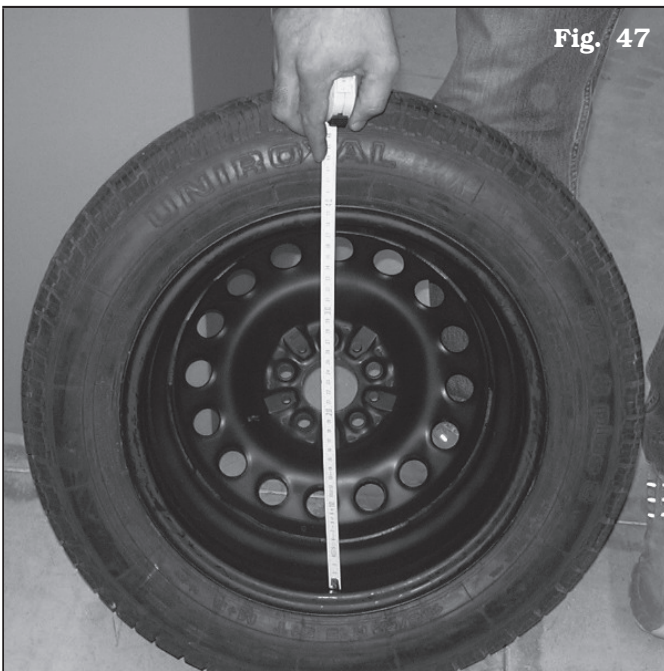

Fig. 47

- Fit the measured wheel on the balancer and lock it on the chuck.

- Turn the gauge ferrule (**Fig. 48 ref. 1**) on the inner edge of the wheel upwards (see **Fig. 48**).



Fig. 48



- Press button  to end the operation. On the monitor the next screen page will be displayed:

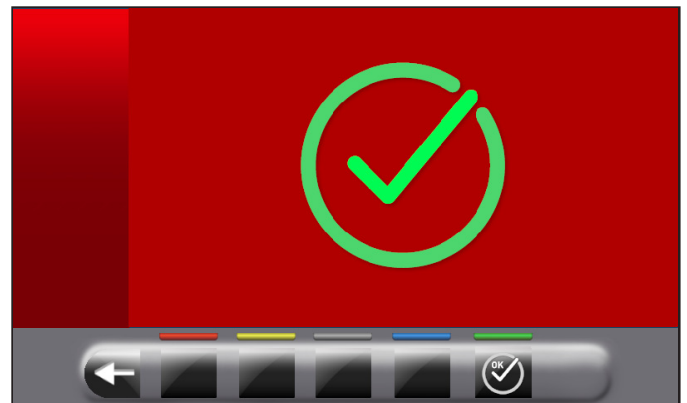

The calibration of the distance-diameter caliper is finished.

Calibration of external data gauge (optional)

THE NUMERICAL VALUES SHOWN IN THE FIGURES BELOW ARE PURELY ILLUSTRATIVE.



Press the button  to display the following screen page on the monitor:

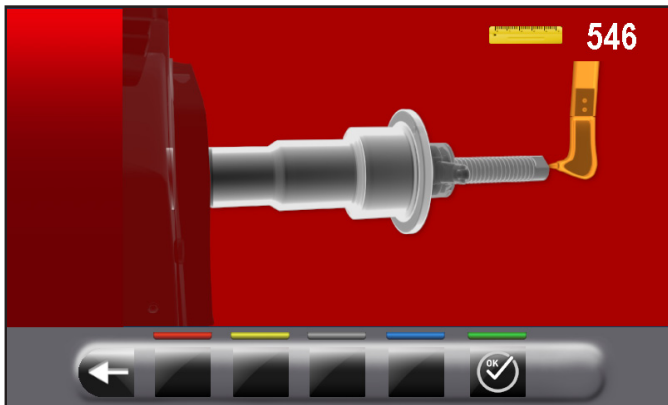

TO PERFORM THIS CALIBRATION, THE CHUCK MUST BE UNLOADED (NO WHEEL OR ACCESSORIES MOUNTED ON IT).

Move the tip of the width measuring device (**Fig. 49 ref. 1**) by the chuck end (**Fig. 49 ref. 2**) (in case of pneumatic chuck, move it next to upper edge of the open chuck).

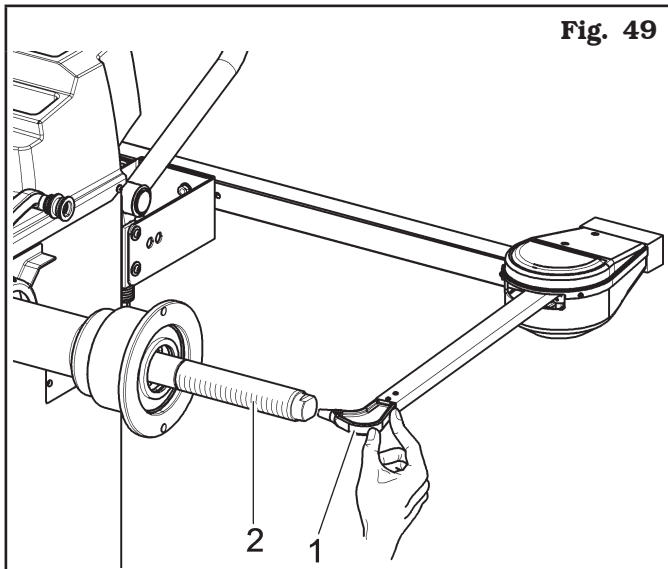

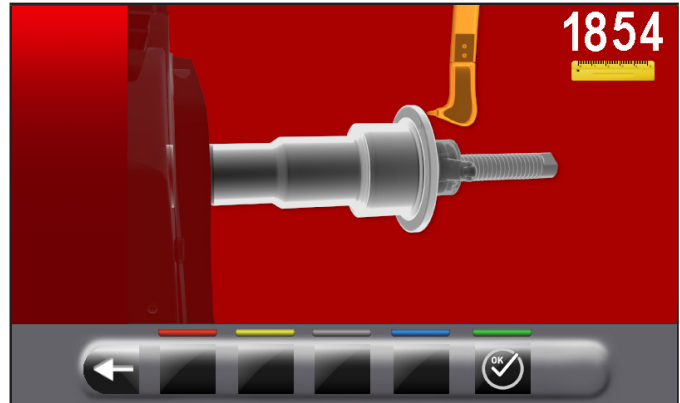

Fig. 49



Press button . On the monitor the next screen page will be displayed:



Move the tip of the width measuring device (**Fig. 50 ref. 1**) in line with the outer surface of the flange (**Fig. 50 ref. 2**).

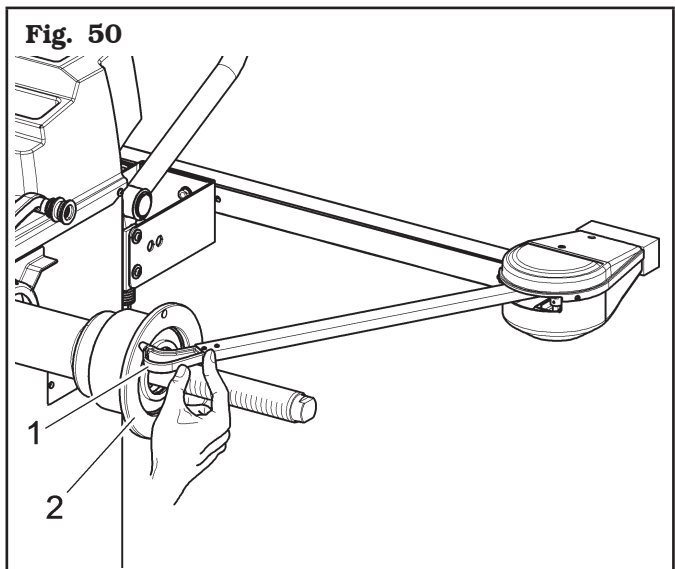

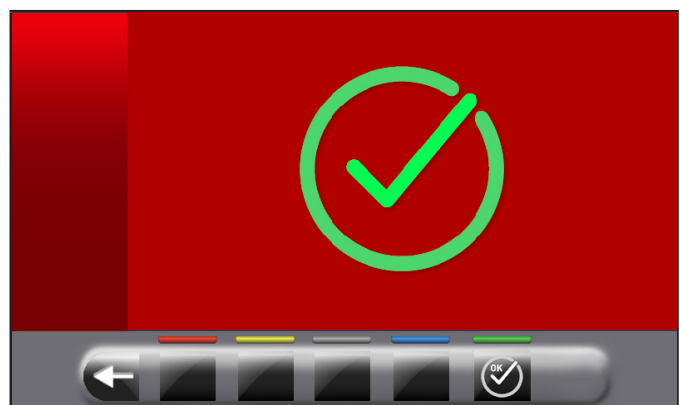

Fig. 50



Press button . At the end of the operation, the following screen will appear on the monitor:



The calibration of the external data gauge is finished.

14.0 ERROR SIGNALS

During wheel balancer operation, if wrong commands are given by the operator or device faults occur, an error code may appear on the monitor screen.

Below is a troubleshooting chart.

Error code	Description
2	Planned wheel speed not reached
3	Calibration overcoming
4	Wheel speed stability out of tolerance
5	Encoder calibration error
6	Encoder samples not sufficient
7	Chuck calibration error
8	Piezo calibration values out of tolerance
9	Wheel rotations not completed
10	Pneumatic chuck open
11	Incorrect gain calibration
12	Distance-diameter caliper value not released
13	Distance-diameter caliper value not released
14	Firmware error
15	Runout samples not sufficient
17	External data gauge enabled
27	Rotate the wheel to make a complete rotation
28	Piezo calibration error
29	Distance out of tolerance level
31	Distance-diameter caliper released
32	Parameters format incompatible

16.0 ROUTINE MAINTENANCE



BEFORE CARRYING OUT ANY ROUTINE MAINTENANCE OR ADJUSTMENT PROCEDURE, POSITION THE MAIN SWITCH "0", DISCONNECT THE MACHINE FROM THE ELECTRICITY SUPPLY USING THE SOCKET/PLUG COMBINATION AND CHECK THAT ALL MOBILE PARTS ARE AT A STANDSTILL.



BEFORE EXECUTING ANY MAINTENANCE OPERATION, MAKE SURE THERE ARE NO WHEELS LOCKED ONTO THE CHUCK.

To guarantee the efficiency and correct functioning of the machine, it is essential to carry out daily or weekly cleaning and weekly routine maintenance, as described below.

Cleaning and routine maintenance must be conducted by authorized personnel and according to the instructions given below.

- Remove deposits of tyre powder and other waste materials with a vacuum cleaner.

DO NOT BLOW IT WITH COMPRESSED AIR.

- Do not use solvents to clean the pressure regulator.



ANY DAMAGE TO THE MACHINE DEVICES RESULTING FROM THE USE OF LUBRICANTS OTHER THAN THOSE RECOMMENDED IN THIS MANUAL WILL RELEASE THE MANUFACTURER FROM ANY LIABILITY!!

17.0 TECHNICAL DATA

17.1 Technical electrical data

Max. absorbed voltage (W)		100
Power supply	Voltage (V)	110 - 230
	Phases	1
	Frequency (Hz)	50/60
Rotation speed (rev/min)		< 100

17.2 Technical mechanical data

Balancing precision (g)	1
Rim width setting (inches)	1.5 ÷ 22
Rim diameter setting (inches)	10 ÷ 26 (automatic) / 10- 30 (manual)
Cycle time (sec)	6
Sound emission level (dBA)	< 70
Max. wheel weight (kg)	65

Weight (Kg)	120
-------------	-----

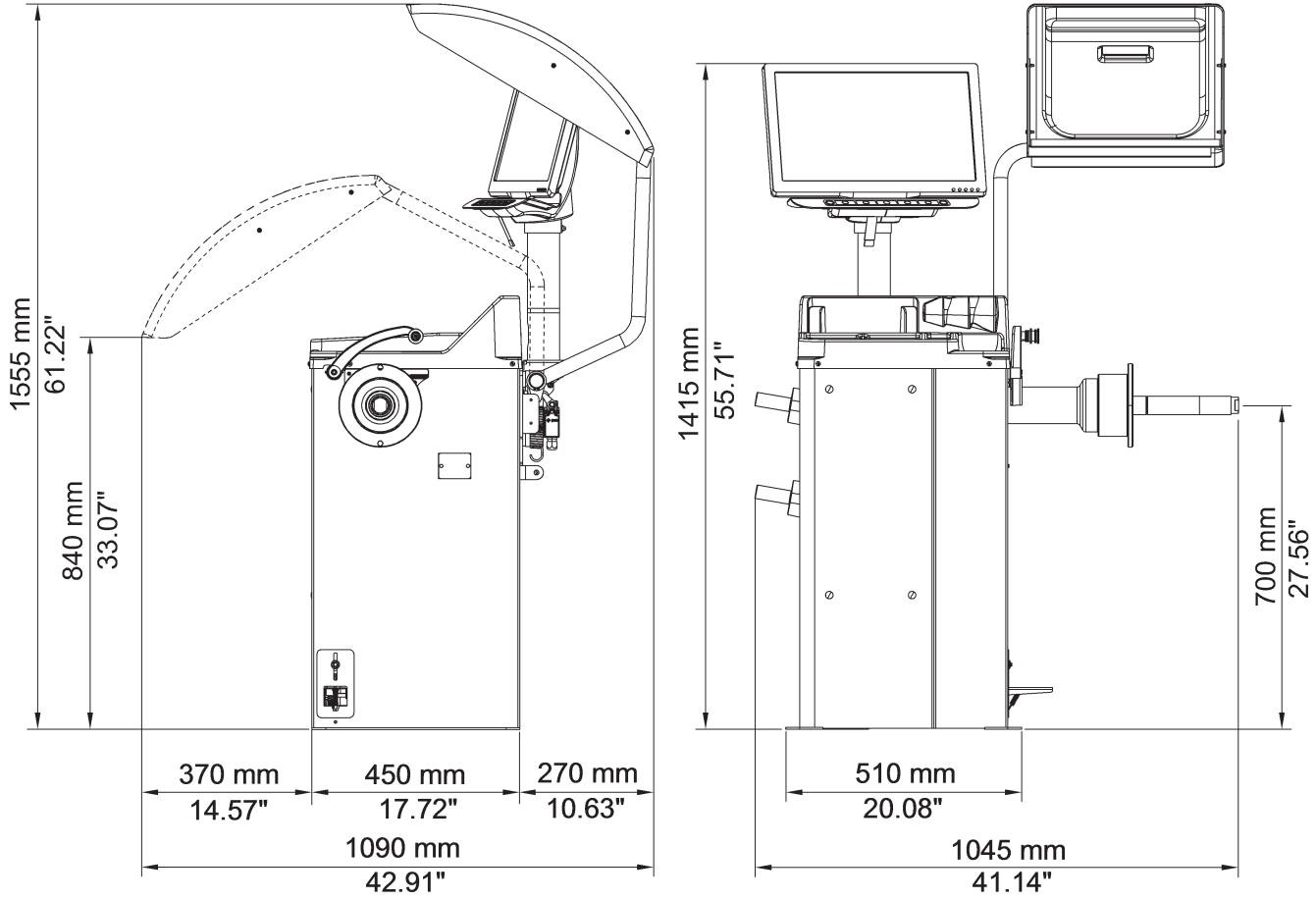
17.3 Dimensions**Fig. 51**

18.0 STORING

If storing for long periods disconnect the main power supply and take measures to protect the machine from dust build-up. Lubricate parts that could be damaged from drying out.

19.0 SCRAPPING

When the decision is taken not to make further use of the machine, it is advisable to make it inoperative by removing the connection pressure pipes. The machine is to be considered as special waste and should be dismantled into homogeneous parts. Dispose of it in accordance with current legislation.

Instructions for the correct management of waste from electric and electronic equipment (WEEE) according to the Italian legislative decree 49/14 and subsequent amendments.

In order to inform the users on the correct way to dispose the product (as required by the article 26, paragraph 1 of the Italian legislative decree 49/14 and subsequent amendments), we communicate what follows: the meaning of the crossed dustbin symbol reported on the equipment indicates that the product must not be thrown among the undifferentiated rubbish (that is to say together with the "mixed urban waste"), but it has to be managed separately, to let the WEEE go through special operations for their reuse or treatment, in order to remove and dispose safely the waste that could be dangerous for the environment and to extract and recycle the raw materials to be reused.

Fig. 52

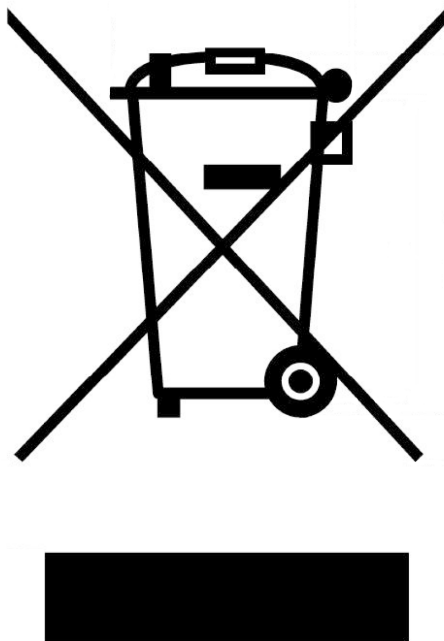

20.0 REGISTRATION PLATE DATA

Butler ENGINEERING and MARKETING S.P.A.		Via Dell'Ecologia, 6 42047 ROLO (RE) ITALY
MODEL		
SERIAL N°		

The validity of the Conformity Declaration enclosed to this manual is also extended to products and/or devices the machine model object of the Conformity Declaration can be equipped with.



ATTENTION: TAMPERING WITH, CARVING, CHANGING ANYHOW OR EVEN REMOVING MACHINE IDENTIFICATION PLATE IS ABSOLUTELY FORBIDDEN; DO NOT COVER IT WITH TEMPORARY PANELS, ETC., SINCE IT MUST ALWAYS BE VISIBLE.

Said plate must always be kept clean from grease residues or filth generally.

WARNING: Should the plate be accidentally damaged (removed from the machine, damaged or even partially illegible) inform immediately the manufacturer.

21.0 FUNCTIONAL DIAGRAMS

Here follows a list of the machine functional diagrams.

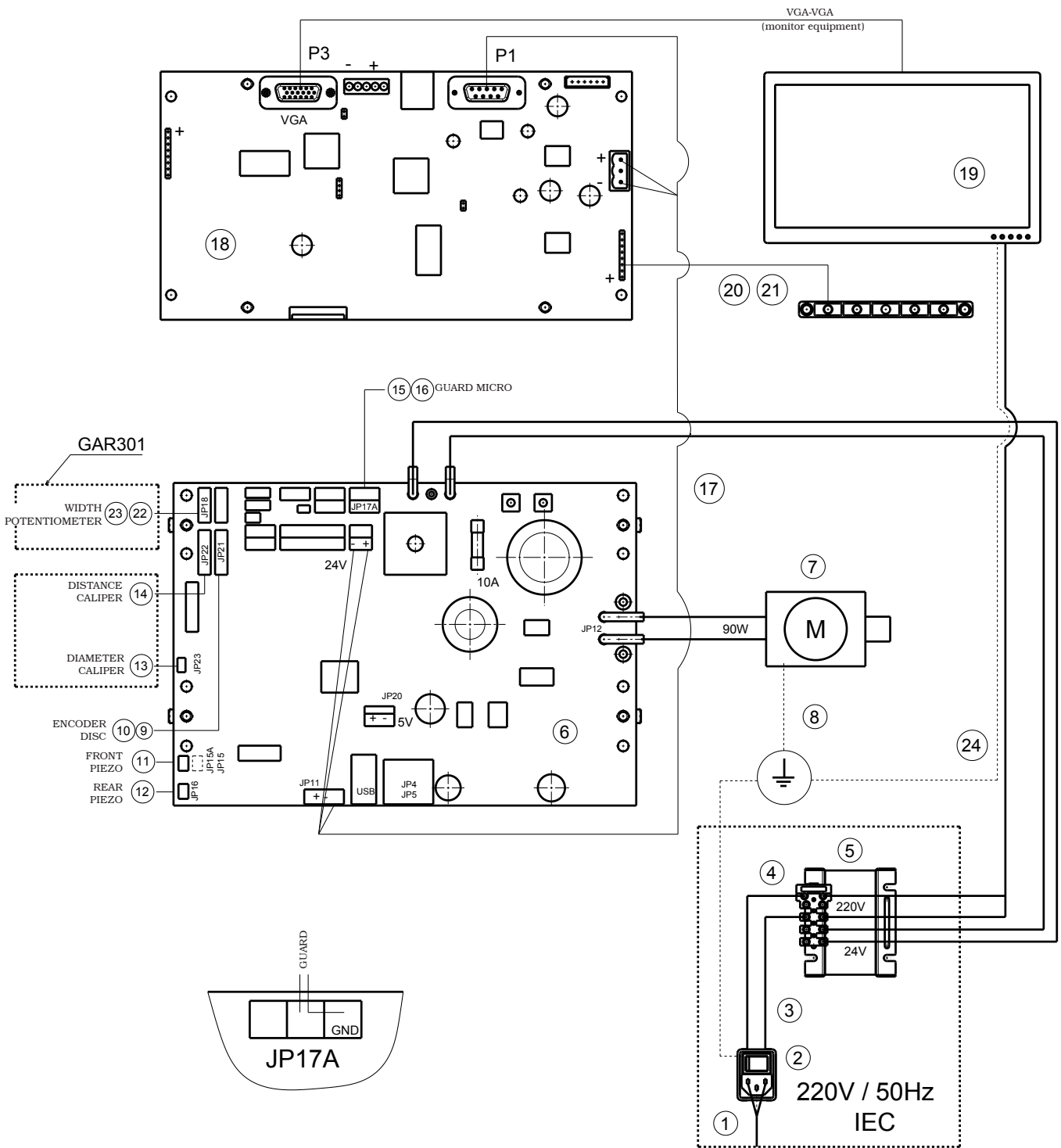

KEY

- | | |
|--------------------------------------|---|
| 1 – Power supply cable | 13 – Potentiometer with cable |
| 2 – Wired switch with plug | 14 – Buffered optical line board |
| 3 – Cable from switch to transformer | 15 – Cable for wheel micro protection |
| 4 – Fuse | 16 – Limit switch |
| 5 – Transformer | 17 – Power supply cable |
| 6 – Card kit | 18 – Monitor card kit |
| 7 – DC motor | 19 – Monitor |
| 8 – Motor support ground cable | 20 – Keyboard cables |
| 9 – Wheel position sensor cable | 21 – 7-keys keyboard |
| 10 – Buffered encoder board | 22 – Width potentiometer extension cable |
| 11 – Piezo with front cable | 23 – Potentiometer with shielded cable |
| 12 – Piezo with cable | 24 – Cable from transformer to power supply |

LIBRAK350

Butler

ENGINEERING and MARKETING S.P.A.

**WIRING CONNECTION
DIAGRAM**

Drawing N°A - Rev. 1

129605560

1296-M024-00

Page 59 of 59

EN



Noi
We / Wir / Nous / Nosotros

BUTLER ENGINEERING AND MARKETING S.p.A.s.u.
Via dell'Ecologia, 6
42047 Rolo RE ITALIA

dichiariamo sotto la nostra esclusiva responsabilità che il prodotto

*declare, undertaking sole responsibility, that the product
erklären unter unserer alleinigen Verantwortung, dass das Produkt
déclarons, sous notre entière responsabilité, que le produit
declaramos bajo nuestra exclusiva responsabilidad, que el producto*

Equilibratrice Wheel Balancer Auswuchtmaschine Équilibreuse de roue Equilibradora	
--	--

al quale questa dichiarazione si riferisce, risponde alle seguenti Direttive applicabili:

*to which this declaration applies is in compliance with the following applicable Directives:
auf das sich diese Erklärung bezieht, den nachstehenden anwendbaren Normen entspricht:
objet de cette déclaration est conforme aux Directives applicables suivantes:
al que se refiere esta declaración cumple con las siguientes Normas aplicables:*

2006/42/CE

Direttiva Macchine

2014/30/UE

Direttiva Compatibilità Elettromagnetica

Per la conformità alle suddette direttive sono state seguite le seguenti Norme Armonizzate:

To comply with the above mentioned Directives, we have followed the following harmonized directives:

In Übereinstimmung mit o.g. Richtlinien wurden folgende harmonisierte Normen befolgt:

Pour la conformité aux normes ci-dessus, nous avons suivi les normes harmonisées suivantes:

Para la conformidad a las Normas arriba mencionadas, hemos seguido las siguientes normas armonizadas:

UNI EN ISO 12100:2010

Sicurezza del macchinario – Principi generali di progettazione – Valutazione del rischio e riduzione del rischio

CEI EN 60204-1:2006/AC:2010

Sicurezza del macchinario – Equipaggiamento elettrico delle macchine – Parte 1: Regole generali

La persona preposta a costituire il fascicolo tecnico è Butler S.p.A. s.u.

The technical documentation file is constituted by Butler S.p.A.s.u.

Vorgesetzte Rechtsperson für die Erstellung des technischen Lastenheftes ist Butler S.p.A.s.u.

La société Butler S.p.A.s.u. est l'organisme délégué à la présentation de la documentation technique.

Butler S.p.A.s.u. es encargada a la constitución del archivo técnico.

BUTLER S.p.A.s.u.