

LOW-RISE SCISSOR LIFT

3,0 T, ELECTRO-HYDRAULIC

The new short-stroke scissor lift XS30N / XS30N-CAT impresses with its generously dimensioned platform length and width, which ensures that a wide range of vehicles can be

accommodated. It covers the requirements in the field of tire and body service and is ideal for maintenance and work in the vehicle interior.

- + Platform length and width matched to modern SUVs and vans
- + Platform extension - Can be locked with just one hand
- + Stable and secure
- + Optional with cataphoresis coating

The standard CE stop ensures foot protection without a foot guard. This also enables underfloor installation.

The optional cataphoretic coating on the mounting platform and base frame provides additional corrosion protection for areas where salt is scattered.

To enable flexible pick-up of both small and large vehicles, the XS30N / XS30N-CAT has ramps that can be folded out on both sides, which ensure a total pick-up length of 2150 mm and can be locked in place with one hand. This also ensures that limousines as well as wide SUVs can be accommodated.

The lift is completely assembled and ready for use immediately after connecting the hydraulics without major installation effort.

The ramps with plastic rollers enable low-friction and gentle rolling on the workshop floor.

The lift has a double hydraulic system and two torsion shafts that can hold the load safely in any situation.

HIGHLIGHTS IN DETAIL

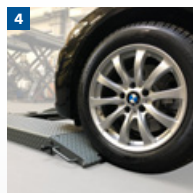
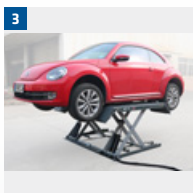

1 To enable flexible accommodation of both small and large vehicles, the XS30N / XS30N-CAT has platform extensions that can be folded out on both sides and easily locked.

2 Two independent hydraulic circuits with a total of 4 lifting cylinders make the absence of additional safety patches possible.

3 The XS30N / XS30N-CAT can be set up on any paved surface without foundation work, anchoring to the floor is possible but not necessary. The lift can be easily moved around in the workshop with the supplied mobile kit.

4 The low drive-over height makes it easier to pick up vehicles with less ground clearance.

XS30N / XS30N-CAT

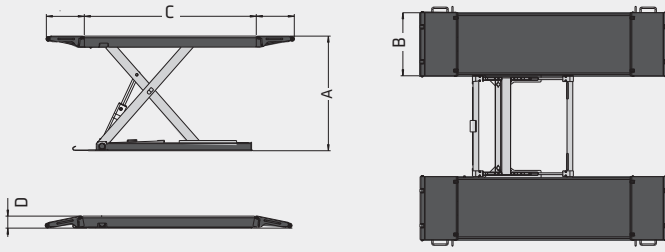

Model	XS30N / XS30N-CAT
Rated load capacity	3.000 kg
A Stroke	1000 mm
Lifting time loaded	30 s
Lowering time loaded	20 s
B Width of runways	530 mm
C Length of runways	1.500-2.150 mm
D Ascending height / Rest height	105 mm
Total width	1.980 mm
Motor power	2.6 kW
Power supply	230 / 400 V, 50 Hz
Weight	530 kg
Article number	XS30N / XS30N-CAT

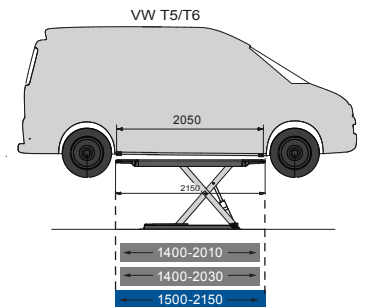
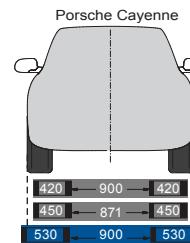
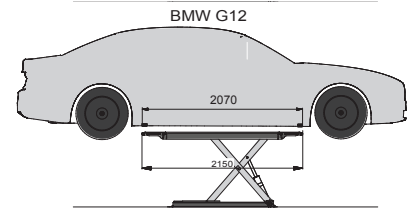
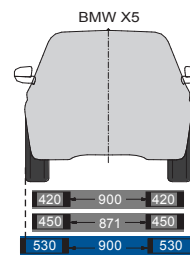
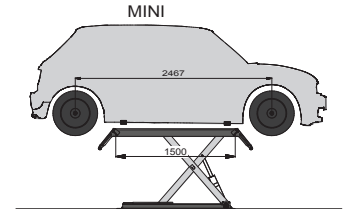
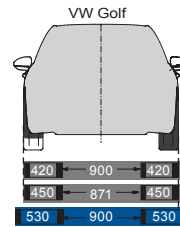
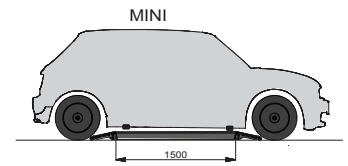
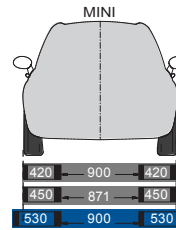

■ Rotary
■ Other manufacturers

ACCESSORIES



- 1 Rubber pads
- 2 Rubber pads
- 3 Long ramps
- 4 Crossbar
- 5 Installation box for floor-level installation
- 6 Installation box for floor level installation including installation frame