

neuer Crafter ab März 2017
new Crafter introduced in March 2017

Vorgängermodell
VW Crafter lang
Stand:12-2013

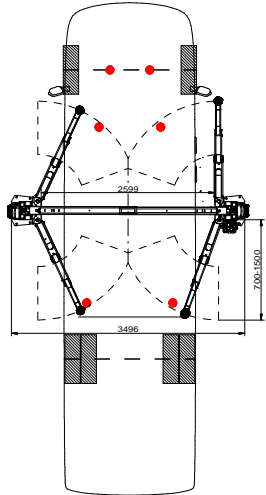

Crafter
L3 F/Q + 4X4

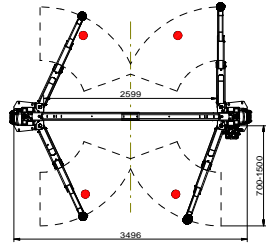

Crafter
L3 Zwilling

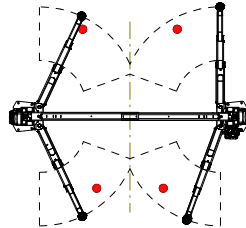

Crafter
L4 F/Q + 4X4

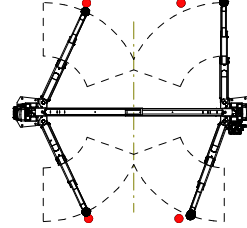

kann nicht aufgenommen werden
can not pick up

Crafter
L4 Zwilling

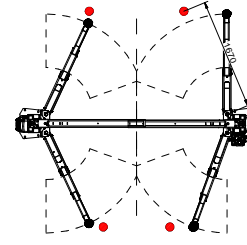

kann nicht aufgenommen werden
can not pick up

Crafter
L5 F/Q + 4X4

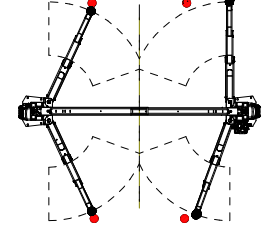

kann nicht aufgenommen werden
can not pick up

Crafter
L5 Zwilling

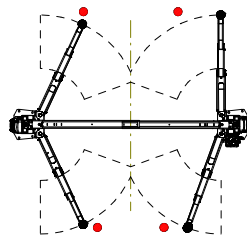

kann nicht aufgenommen werden
can not pick up

Crafter
Doka L3 Zwilling
H/L + F/Q

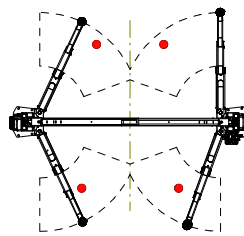

Crafter
Doka Zwilling
H/L F4 + F/Q

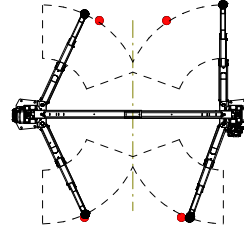

kann nicht aufgenommen werden
can not pick up

Crafter
Eika F/Q L3

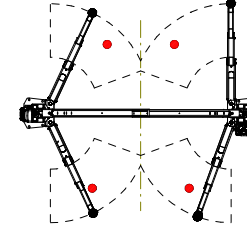

Crafter
Eika F/Q L4

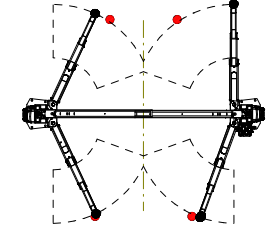

kann nicht aufgenommen werden
can not pick up

nur die alternativen Aufnahmepunkte erreichbar.
only the alternative pick-up points available

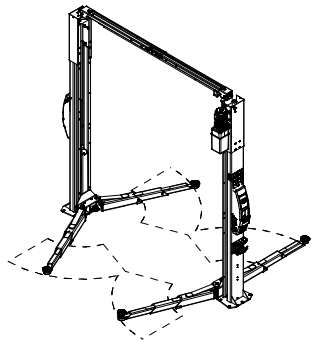

				THIRD ANGLE PROJECTION		SPO40E-5	
				DO NOT SCALE DRAWING		ROTARY LIFT	
				UNLESS OTHERWISE NOTED: ANGULAR DIMENSIONS: +1° - OTHER DIMENSIONS: +0.8mm (<305mm) +/- 1.6mm (>or= 305mm)		A DOVER COMPANY	
				UNLESS OTHERWISE SPECIFIED: 0.5mm MIN. CORNER BREAK REMOVE ALL BURRS			
NOTES:				MiGo		DRAWING NUMBER	
				APPROVED: DATE 05.01.2017		SPO40E-5_8548	
REV	CO NUM	DATE	BY	The design and detail illustrated in this drawing is the property of Rotary Lift. It is being loaned with the expressed condition that it will not be duplicated or used except by permission and is subject to return upon request.			